

Model 3930A Multifunction Synthesizer

Operator's Manual

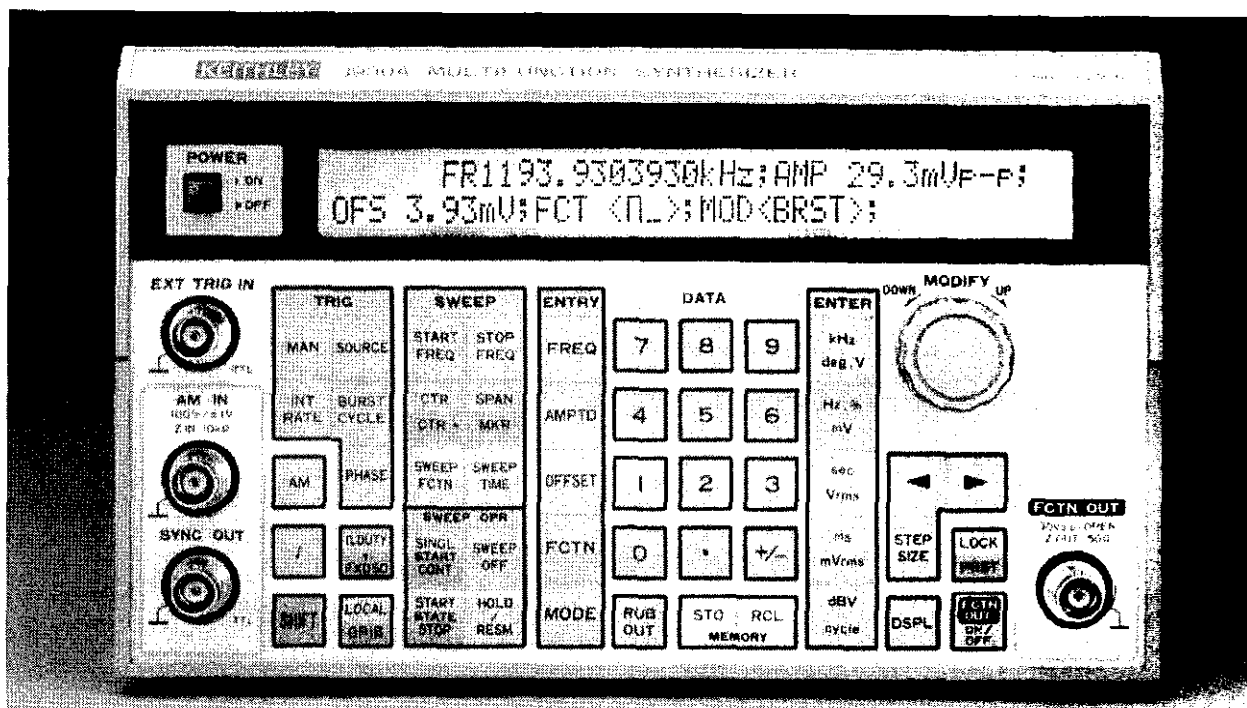

Contains Operating and Servicing Information



WARRANTY

Keithley Instruments, Inc. warrants this product to be free from defects in material and workmanship for a period of 1 year from date of shipment.

Keithley Instruments, Inc. warrants the following items for 90 days from the date of shipment: probes, cables, rechargeable batteries, diskettes, and documentation.

During the warranty period, we will, at our option, either repair or replace any product that proves to be defective.

To exercise this warranty, write or call your local Keithley representative, or contact Keithley headquarters in Cleveland, Ohio. You will be given prompt assistance and return instructions. Send the product, transportation prepaid, to the indicated service facility. Repairs will be made and the product returned, transportation prepaid. Repaired or replaced products are warranted for the balance of the original warranty period, or at least 90 days.

LIMITATION OF WARRANTY

This warranty does not apply to defects resulting from product modification without Keithley's express written consent, or misuse of any product or part. This warranty also does not apply to fuses, software, non-rechargeable batteries, damage from battery leakage, or problems arising from normal wear or failure to follow instructions.

THIS WARRANTY IS IN LIEU OF ALL OTHER WARRANTIES, EXPRESSED OR IMPLIED, INCLUDING ANY IMPLIED WARRANTY OF MERCHANTABILITY OR FITNESS FOR A PARTICULAR USE. THE REMEDIES PROVIDED HEREIN ARE BUYER'S SOLE AND EXCLUSIVE REMEDIES.

NEITHER KEITHLEY INSTRUMENTS, INC. NOR ANY OF ITS EMPLOYEES SHALL BE LIABLE FOR ANY DIRECT, INDIRECT, SPECIAL, INCIDENTAL OR CONSEQUENTIAL DAMAGES ARISING OUT OF THE USE OF ITS INSTRUMENTS AND SOFTWARE EVEN IF KEITHLEY INSTRUMENTS, INC., HAS BEEN ADVISED IN ADVANCE OF THE POSSIBILITY OF SUCH DAMAGES. SUCH EXCLUDED DAMAGES SHALL INCLUDE, BUT ARE NOT LIMITED TO: COSTS OF REMOVAL AND INSTALLATION, LOSSES SUSTAINED AS THE RESULT OF INJURY TO ANY PERSON, OR DAMAGE TO PROPERTY.

The logo for Keithley, consisting of the word "KEITHLEY" in a bold, white, sans-serif font, set against a solid black rectangular background.

Test Instrumentation Group, Keithley Instruments, Inc. • 28775 Aurora Road • Cleveland, Ohio 44139 • (216) 248-0400 • Fax: (216) 248-6168

CHINA: Keithley Instruments, Inc. • Holiday Inn Lido • Office Building 404C • Beijing, China, 100004 • 8610-436-2871/2860 • 8610-436-2871

FRANCE: Keithley Instruments SARL • 3 Allée des Garays • B.P. 60 • 91122 Palaiseau Cédex • 01-60-11-51-55 • Fax: 01-60-11-77-26

GERMANY: Keithley Instruments GmbH • Landsberger Str. 65 • 82110 Germering • 089-849307-0 • Fax: 089-84930759

GREAT BRITAIN: Keithley Instruments, Ltd. • The Minster • 58 Portman Road • Reading, Berkshire RG30 1EA • 01734-575666 • Fax: 01734-596469

ITALY: Keithley Instruments SRL • Viale S. Girmignano 38 • 20146 Milano • 02-48303008 • Fax: 02-48302274

JAPAN: Keithley Instruments Far East KK • Sumiyoshi 24 Bldg., Room 201 • 2-24-2 Sumiyoshi-cho • Naka-ku, Yokohama 231 • 81-45-201-2246 • Fax: 81-45-201-2247

NETHERLANDS: Keithley Instruments BV • Avelingen West 49 • 4202 MS Gorinchem • Postbus 559 • 4200 AN Gorinchem • 01830-35333 • Fax: 01830-30821

SWITZERLAND: Keithley Instruments SA • Kriesbachstrasse 4 • 8600 Dübendorf • 01-821-9444 • Fax: 01-820-3081

Model 3930A Multifunction Synthesizer Operator's Manual

© 1991, Keithley Instruments, Inc.
Test Instrumentation Group
All rights reserved.
Cleveland, Ohio, U.S.A.
August 1991, First Printing
Document Number: 3930A-900-01 Rev. A

All Keithley product names are trademarks or registered trademarks of Keithley Instruments, Inc.

Other brand and product names are trademarks or registered trademarks of their respective holders.

Safety Precautions

The following safety precautions should be observed before using the Model 3930A Multifunction Synthesizer and any associated instruments.

This instrument is intended for use by qualified personnel who recognize shock hazards and are familiar with the safety precautions required to avoid possible injury. Read over this manual carefully before using the instrument.

Exercise extreme caution when a shock hazard is present at the test circuit. The American National Standards Institute (ANSI) states that a shock hazard exists when voltage levels greater than 30V rms or 42.4V peak are present. **A good safety practice is to expect that hazardous voltage is present in any unknown circuit before measuring.**

Inspect the connecting cables and test leads for possible wear, cracks, or breaks before each use.

For maximum safety, do not touch the test cables or any instruments while power is applied to the circuit under test. Turn off the power and discharge any capacitors before connecting or disconnecting cables from the instrument.

Do not touch any object which could provide a current path to the common side of the circuit under test or power line (earth) ground. Always make measurements with dry hands while standing on a dry, insulated surface capable of withstanding the voltage being measured.

Instrumentation and accessories should not be connected to humans.

Table of Contents

SECTION 1 — General Information

1.1	INTRODUCTION	1-1
1.2	FEATURES	1-1
1.3	WARRANTY INFORMATION	1-2
1.4	MANUAL ADDENDA	1-2
1.5	SAFETY TERMS AND SYMBOLS	1-2
1.6	UNPACKING AND REPACKING	1-2
1.6.1	Unpacking	1-2
1.6.2	Shipment Contents	1-2
1.6.3	Operator's Manual	1-2
1.6.4	Repacking For Shipment	1-3
1.7	OPTIONAL ACCESSORIES	1-3
1.8	SPECIFICATIONS	1-3

SECTION 2 — Getting Started

2.1	INTRODUCTION	2-1
2.2	INSTALLATION	2-1
2.2.1	Installation Location	2-1
2.2.2	Fan	2-1
2.3	LINE POWER SUPPLY	2-2
2.3.1	LINE Voltage Selector Switch	2-2
2.3.2	Line Receptacle Connection	2-2
2.3.3	Line Fuse	2-2
2.4	HANDLING PRECAUTIONS	2-3
2.5	BASIC OPERATION	2-3
2.5.1	Front Panel Summary	2-3
2.5.2	Typical Test Connections	2-3
2.5.3	Operating Examples	2-5

SECTION 3 — Operation

3.1	INTRODUCTION	3-1
3.2	FRONT PANEL AND REAR PANEL DESCRIPTION	3-1
3.2.1	Front Panel Description	3-1
3.2.2	Rear Panel Description	3-12
3.3	Input and Output Connections	3-13
3.3.1	Input Connections	3-13
3.3.2	Output Connections	3-14
3.4	STARTUP	3-15
3.5	OPERATING PROCEDURES	3-16
3.5.1	Setting Parameters Using Numeric Keys	3-16

3.5.2	Setting Parameters using MODIFY	3-17
3.5.3	Error Codes	3-17
3.5.4	Units Conversion	3-19
3.5.5	Frequency Programming	3-20
3.5.6	Output Amplitude and Amplitude Modulation	3-21
3.5.7	DC Offset Programming	3-21
3.5.8	Waveform Selection, Square-Wave Duty Cycle, and Synchronous Output	3-23
3.5.9	Oscillation Mode	3-24
3.5.10	Trigger Parameters (Source, Rate, Burst Cycle, and Phase)	3-27
3.5.11	Frequency Sweep Operation	3-29
3.5.12	Output Range Mode	3-34

SECTION 4 — GPIB Interface

4.1	INTRODUCTION	4-1
4.1.1	GPIB Overview	4-1
4.1.2	Major GPIB Specifications	4-1
4.1.3	Bus Line Signals and Operation	4-2
4.1.4	GPIB Handshaking	4-2
4.1.5	Data Transfer Example	4-3
4.1.6	Basic Talker Functions	4-3
4.1.7	Basic Listener Functions	4-3
4.1.8	Basic Controller Functions	4-4
4.1.9	Multi-Line Interface Messages	4-4
4.2	OVERVIEW OF MODEL 3930A GPIB INTERFACE	4-6
4.2.1	Introduction	4-6
4.2.2	Specifications	4-6
4.3	MODEL 3930A PROGRAM CODES	4-10
4.3.1	Model 3930A Parameter-Setting Messages	4-10
4.3.2	Model 3930A Inquiry Messages	4-21
4.4	MODEL 3933A PHASE SHIFTER PROGRAM CODES	4-26
4.4.1	Model 3933A Phase Shifter Parameter Setting Messages	4-26
4.4.2	Model 3933A Phase Shifter Inquiry Messages	4-32
4.5	TYPICAL EXECUTION TIMES	4-35
4.6	PROGRAM CODE SUMMARY TABLES	4-38
4.7	SAMPLE PROGRAMS	4-43

List of Illustrations

SECTION 2 — Getting Started

Figure 2-1	Front Panel Summary	2-4
Figure 2-2	Typical Connections	2-5

SECTION 3 — Operation

Figure 3-1	Model 3930A Front Panel	3-2
Figure 3-2	Model 3930A Rear Panel	3-11
Figure 3-3	Logic Input Circuit	3-13
Figure 3-4	Amplitude Modulation Input Circuit	3-14
Figure 3-5	Internal Trigger Output	3-14
Figure 3-6	Synchronous Output	3-14
Figure 3-7	Sweep Marker and Sweep Synchronous Outputs	3-14
Figure 3-8	Relational Range for Allowed AC Amplitude Voltage and DC	3-22
Figure 3-9	Phase Relationship between Waveform and Synchronous Output	3-25
Figure 3-10	Burst Oscillation Mode Example	3-26
Figure 3-11	Gate Oscillation Example Using Square Wave	3-26
Figure 3-12	Gate Oscillation Example Showing Completion of Oscillation Cycle	3-26
Figure 3-13	Waveforms and Phase Definitions	3-28
Figure 3-14	Relationship Between Sweep Frequency and Sweep Output	3-31
Figure 3-15	Output Resolution and Number of Digits for AC Only	3-36
Figure 3-16	Setting Resolution and Number of Digits for DC Only	3-37

SECTION 4 — GPIB Interface

Figure 4-1	Interface Connector	4-2
Figure 4-2	Handshake Timing Diagram	4-3
Figure 4-3	Data Transfer Example	4-4
Figure 4-4	Program Code Syntax	4-7
Figure 4-5	Response Output Format	4-9

Appendix A — Typical Data

Figure A-1	Sine Wave Amplitude vs. Frequency Characteristics	A-2
Figure A-2	Total Harmonic Distortion vs. Frequency Characteristics	A-2

List of Tables

SECTION 2 — Getting Started

Table 2-1	Fuse Replacement	2-3
-----------	----------------------------	-----

SECTION 4 — GPIB Interface





Table 4-1	Multi-line Interface Messages	4-5
Table 4-2	Interface Functions	4-6
Table 4-3	Bus Driver Specifications	4-6
Table 4-4	Response to Interface Messages	4-7
Table 4-5	Status Byte	4-11
Table 4-6	Model 3930A Main Parameter Setting Messages	4-12
Table 4-7	Model 3930A Trigger Parameter Setting Messages	4-14
Table 4-8	Model 3930A Sweep Parameter Setting Messages	4-16
Table 4-9	Model 3930A Miscellaneous Parameter Messages	4-19
Table 4-10	Parameter Messages Specific to Model 3930A GPIB	4-20
Table 4-11	Main Parameter Inquiry Messages	4-21
Table 4-12	Model 3930A Trigger Parameter Inquiry Messages	4-22
Table 4-13	Model 3930A Sweep Parameter Inquiry Messages	4-23
Table 4-14	Model 3930A Miscellaneous Parameter Inquiry Messages	4-24
Table 4-15	Inquiry Messages for Parameters Specific to Model 3930A GPIB	4-25
Table 4-16	Model 3933A Phase Shifter Main Parameter Setting Range	4-26
Table 4-17	Model 3933A Phase Shifter Sweep Parameter Setting Messages	4-28
Table 4-18	Model 3933A Phase Shifter Miscellaneous Parameter Setting Messages	4-30
Table 4-19	Parameter Setting Messages Specific to Model 3933A Phase Shifter GPIB	4-31
Table 4-20	Model 3933A Phase Shifter Main Parameter Inquiry Messages	4-32
Table 4-21	Model 3933A Phase Shifter Sweep Parameter Inquiry Messages	4-33
Table 4-22	Model 3933A Phase Shifter Miscellaneous Parameter Inquiry Messages	4-33
Table 4-23	Inquiry Messages for Parameters Specific to Model 3933A Phase Shifter GPIB	4-34
Table 4-24	Typical Execution Times	4-35
Table 4-25	Model 3930A Program Code Summary	4-38
Table 4-26	Model 3933A Phase Shifter Program Code Summary	4-41

SECTION 1

General Information

1.1 INTRODUCTION

The Model 3930A Multifunction Synthesizer can generate frequencies between 0.1mHz and 1.2MHz. The Model 3930A can generate the entire frequency band at a resolution of 0.1mHz, with a high-frequency accuracy of ± 5 ppm.

Five AC waveforms, , , , , and  are available. Maximum output voltage for all waveforms is 30V p-p/no load or 15Vp-p/50 Ω load.

Since frequencies are synthesized directly by a custom LSI digital IC, accuracy and stability are high, and the frequency switching time is short. Another advantage is the continuity of phase at frequency switchover.







Frequency sweep, amplitude modulation (AM), burst oscillation of up to 65,536 cycles, and gate oscillation are available. The Model 3930A also employs a built-in trigger generator, and the square-wave duty cycle is also variable. Combined with the optional Model 3933A Phase Shifter, the Model 3930A forms a multiphase oscillator.

The Model 3930A uses a two-line, 40-character liquid crystal display to display selected functions, parameters,

and pertinent messages. Parameter settings are easily made using both the numeric keys and the MODIFY knob.

The Model 3930A is equipped with a standard GPIB (IEEE-488) interface and can be programmed over the bus for the same operating modes and parameters that can be controlled from the front panel.

1.2 FEATURES

- Wide bandwidth: 0.1mHz to 1.2MHz (resolution: 0.1mHz).
- ± 5 ppm frequency accuracy.
- Phase continuity at frequency switchover.
- Frequency can be set by period in addition to frequency.
- Five AC waveforms available: , , , , and .
- The duty cycle can be set to values between 5% and 95% for frequencies up to 100kHz.
- High output: 30Vp-p/no load, 15Vp-p/50 Ω load.
- AC output voltages can be set in p-p, rms, or dBV units, and units conversion is also available.
- AC voltage accuracy: $\pm 0.5\%$ (≤ 50 kHz, , 3Vp-p or greater).
- Low distortion: 0.1% or less (10kHz to 100kHz above 30mVp-p, when output range is AUTO).
- Amplitude modulation of AC output waveforms by an externally applied signal.

- DC offset and DC output voltages available: $\pm 15V$ /no load, $\pm 7.5V/50\Omega$ load.
- Burst oscillation and gate oscillation modes:
Number of burst oscillation cycles: 1 cycle to 65,536 cycles.
Start/stop phase: -360° to 360° .
Trigger source: External/internal and trailing/edge are selectable.
Internal trigger period: $1\mu\text{sec}$ to 2999.9sec.
- A wide variety of frequency sweep functions and associated input and output signals:
Sweep functions: \square , LIN/LOG, \wedge / \nearrow .
CONT/SINGLE and HOLD/RESUME sweep operations.
Sweep time: 5msec to 9999sec.
SYNC, MARKER, and X DRIVE output signals.
SINGL START and HOLD input signals.
- Each parameter setting can be performed using either the numeric keys or the MODIFY knob and keys. The two-line, 40 character LCD clearly displays all necessary information. Various modification steps sizes are available: ± 1 , ± 5 , $\times 2$, and $\times 10$.
- Battery backed-up memory stores up 10 configuration settings in addition to the configuration in effect when power is turned off.
- Standard GPIB interface allows the Model 3930A to be programmed over the GPIB (IEEE-488 interface bus).
- Digital I/O allows the Model 3930A to be used as a multiphase oscillator in conjunction with the optional Model 3933A Phase Shifter.
- Output range mode can be switched from automatic (AUTO) to fixed (FXD).

1.3 WARRANTY INFORMATION

Warranty information is located on the inside front cover of this operator's manual. Should your Model 3930A require warranty service, contact the Keithley representative or authorized repair facility in your area for further information. When returning the instrument for repair, be sure to fill out and include the service form at the back of this manual in order to provide the repair facility with the necessary information.

1.4 MANUAL ADDENDA

Any improvements or changes concerning the instrument or manual will be explained in an addendum included with the unit. Be sure to note these changes and incorporate them into the manual before using the unit.

1.5 SAFETY TERMS AND SYMBOLS

The following safety terms and symbols are found on the instrument or used in this manual.

The  symbol on the instrument indicates that the user should refer to the operating instructions.

The **WARNING** heading used in this manual explains dangers that might result in personal injury or death. Always read the associated information very carefully before performing the indicated procedure.

The **CAUTION** heading used in this manual explains hazards that could damage the instrument. Such damage may invalidate the warranty.

1.6 UNPACKING AND REPACKING

1.6.1 Unpacking

After carefully unpacking the instrument from its shipping carton, inspect it for any obvious signs of physical damage. Report any such damage to the shipping agent immediately. Save the original packing carton for storage or possible future shipment.

1.6.2 Shipment Contents

The following items are included with every Model 3930A order:

- Model 3930A Multifunction Synthesizer
- Model 3930A Operator's Manual.
- Power cord
- Fuse (1A, 250V, $5 \times 20\text{mm}$)
- BNC to BNC signal cable
- Additional accessories as ordered.

1.6.3 Operator's Manual

If an additional manual is required, order the manual package, Keithley part number 3930A-900-00. The manual package includes an operator's manual and any pertinent addenda.

1.6.4 Repacking For Shipment

Should it become necessary to return the Model 3930A for repair, carefully pack the unit in its original packing carton or the equivalent. Be sure to use a cardboard box of sufficient strength if the original carton is not used.

Include the following information:

- Advise as to the warranty status of the instrument.
- Write ATTENTION REPAIR DEPARTMENT on the shipping label.
- Fill out and include the service form located at the back of this manual.

1.7 OPTIONAL ACCESSORIES

The following accessories are available for use with the Model 3930A.

Models 3900-1 and 3900-2 Rack Mounting Kits: The Model 3900-1 mounts one Model 3930A in a standard 19 inch rack. The Model 3900-2 mounts two Model 3930As side by side in a standard 19 inch rack. Both kits include all necessary hardware for proper rack mounting of the instruments.

Model 7007 Shielded IEEE-488 Cables: The Model 7007-1 (1m, 3.3ft.) and Model 7007-2 (2m, 6.6ft.) can be used to interface the Model 3930A to the IEEE-488 bus.

Model 7051-2 BNC-to-BNC Cable: The Model 7051-2 is 50 Ω BNC to BNC cable (RG-58C) 2ft. (0.6m) in length. The Model 7051-2 is terminated with male BNC connectors on both ends.

Model 7051-5 BNC-to-BNC Cable: The Model 7051-5 is 50 Ω BNC to BNC cable (RG-58C) 5ft. (1.2m) in length. The Model 7051-5 is terminated with male BNC connectors on both ends.

Model 7051-10 BNC-to-BNC Cable: The Model 7051-10 is similar to the Models 7051-2 and 7051-5 except that it is 10ft. in length.

Model 7754-3 BNC-to-Alligator Cable: The Model 7754-3 is a 3ft. (0.9m) 50 Ω cable (RG-58C), terminated with a male BNC connector on one end and two alligator clips on the other end.

Model 7755 50 Ω Feed-through Terminator: The Model 7755 is a BNC to BNC adapter that is terminated with a 50 Ω resistor. VSWR is <1.1, DC to 250MHz.

1.8 SPECIFICATIONS

Detailed Model 3930A specifications may be found in Appendix B.

SECTION 2

Getting Started

2.1 INTRODUCTION

This section contains basic information on installation, power line connections, and it also provides typical simple operating examples.

2.2 INSTALLATION

The following paragraphs discuss Model 3930A installation. In particular, use adequate care when installing the unit. Improper installation will adversely affect the life, reliability, and safety of the unit.

The Model 3930A weighs about 10 lbs; be careful when carrying the unit or mounting it in a rack.

2.2.1 Installation Location

The allowable ambient temperature and humidity ranges for the Model 3930A are.

Operating: 0 to 40°C, 10 to 90%RH
Storage: -10 to 50°C, 10 to 80%RH

Be sure to install the unit in a location that satisfies these temperature and humidity conditions. Also the environment must be free of dust and vibration, and the Model 3930A must not be exposed to direct sunlight.

The Model 3930A uses a line filter, but pulse noise or strong magnetic or electric fields may cause incorrect operation of the unit. Do not install the unit near a source of pulse noise or strong magnetic or electric fields.

The guard on the rear panel of the unit is designed to protect rear panel connectors and should not be used as a leg for installation. Do not stand the unit vertically on the rear guard because it may fall over, causing instrument damage or personal injury.

2.2.2 Fan

The Model 3930A is air-cooled by a fan. Insufficient air flow may cause a component in the unit to fail. Follow the instructions given below.

CAUTION

Observe the following precautions to prevent damage to the unit:

- An air intake port is provided on the rear panel of the unit. Allow a space of at least

four inches between the rear panel and a wall or other obstruction.

- An exhaust port is provided on the bottom panel of the unit. Install the unit on a rigid, flat surface, and avoid installing it on soft material such as a cushion. Be careful not to insert foreign material between the bottom of the unit and the surface underneath. Another exhaust port is located on the top panel of the unit. Be careful not to block the top port by placing an object on top of the unit.
- Avoid mounting two or more units vertically. Placing one unit on top of another will obstruct the exhaust port.
- Dust collecting in the fan filter will prevent sufficient air flow. In clean operating environments, wash the filter with a mild detergent every three months. When operating the unit in a dusty environment, wash the filter with a mild detergent at least once a month.
- Immediately turn off the power to the unit if the fan ceases to operate. Operating the instrument with the fan inoperative may result in damage to the instrument.

2.3 LINE POWER SUPPLY

The Model 3930A operates with a 100V, 120V, 220V, or 240V $\pm 10\%$, 48 to 62Hz, single-phase AC power supply. The power consumption is 41VA.

2.3.1 LINE Voltage Selector Switch

The LINE voltage selector switch on the rear panel allows you to change operating voltage of the power supply. The standard setting of the switch is the same as the voltage available in the country to which the unit is shipped.

To change the power supply voltage, first disconnect the line cord, and set the supply voltage switch in the correct position. Wait at least five seconds before turning the power back on after turning it off.

WARNING

Disconnect the power cord from the instrument before changing the supply voltage setting.

CAUTION

Be sure to set the line voltage switch to the correct position for the line power voltage to be used. Operating the instrument on an incorrect voltage may cause damage to the unit.

2.3.2 Line Receptacle Connection

Connect the supplied power cord to the rear panel Line receptacle and to a grounded AC power receptacle supplying the correct voltage.

WARNING

The Model 3930A is equipped with a 3-wire power cord that contains a separate ground wire and is designed to be used with grounded outlets. When proper connections are made, instrument chassis is connected to the power line ground. If the AC outlet is not grounded, the rear panel ground terminal  must be connected to safety earth ground using #18AWG (or larger) wire before use.

2.3.3 Line Fuse

The line fuse, protects the instrument from over-current situations. To replace the fuse, first disconnect the line cord, and unscrew the fuse carrier from the fuse holder. Replace the blown fuse only with the type listed in Table 2-1, then replace the fuse holder.

WARNING

Disconnect the line cord from the instrument before replacing the fuse.

CAUTION

Use only a fuse of the rating listed in Table 2-1, or instrument damage may occur.

Table 2-1. Fuse Replacement

Line Voltage	Fuse Current Rating
110V, 120V 220, 240V	1A 1/2A

NOTE: Fuses are 5 × 20mm and have 250V, normal blow ratings.

2.4 HANDLING PRECAUTIONS

A flat keyboard coated with a polyester film forms the control panel surface of the Model 3930A. Be careful not to damage the keyboard surface by cutting it with a sharp instrument or touching it with a hot object.

When the panel or case becomes dirty, clean it with a soft cloth. If the panel or case is too dirty for cleaning with a dry cloth, dampen the cloth in mild detergent, and wipe the panel or case with the damp cloth. Never use solvents

such as thinner or benzene, or chemical dust cloths to avoid damaging the case or front panel surfaces.

2.5 BASIC OPERATION

The following paragraphs summarize front panel operating controls, give typical test connections, and discuss typical operating examples for the Model 3930A.

2.5.1 Front Panel Summary

Figure 2-1 summarizes each front panel feature. For detailed information on each operating feature, refer to Section 3.

2.5.2 Typical Test Connections

Figure 2-2 shows typical test connections between the Model 3930A main synthesizer and a DUT. Note that 50Ω characteristic impedance cables such as the Model 7051 should be used for output connections.

SECTION 2
Getting Started

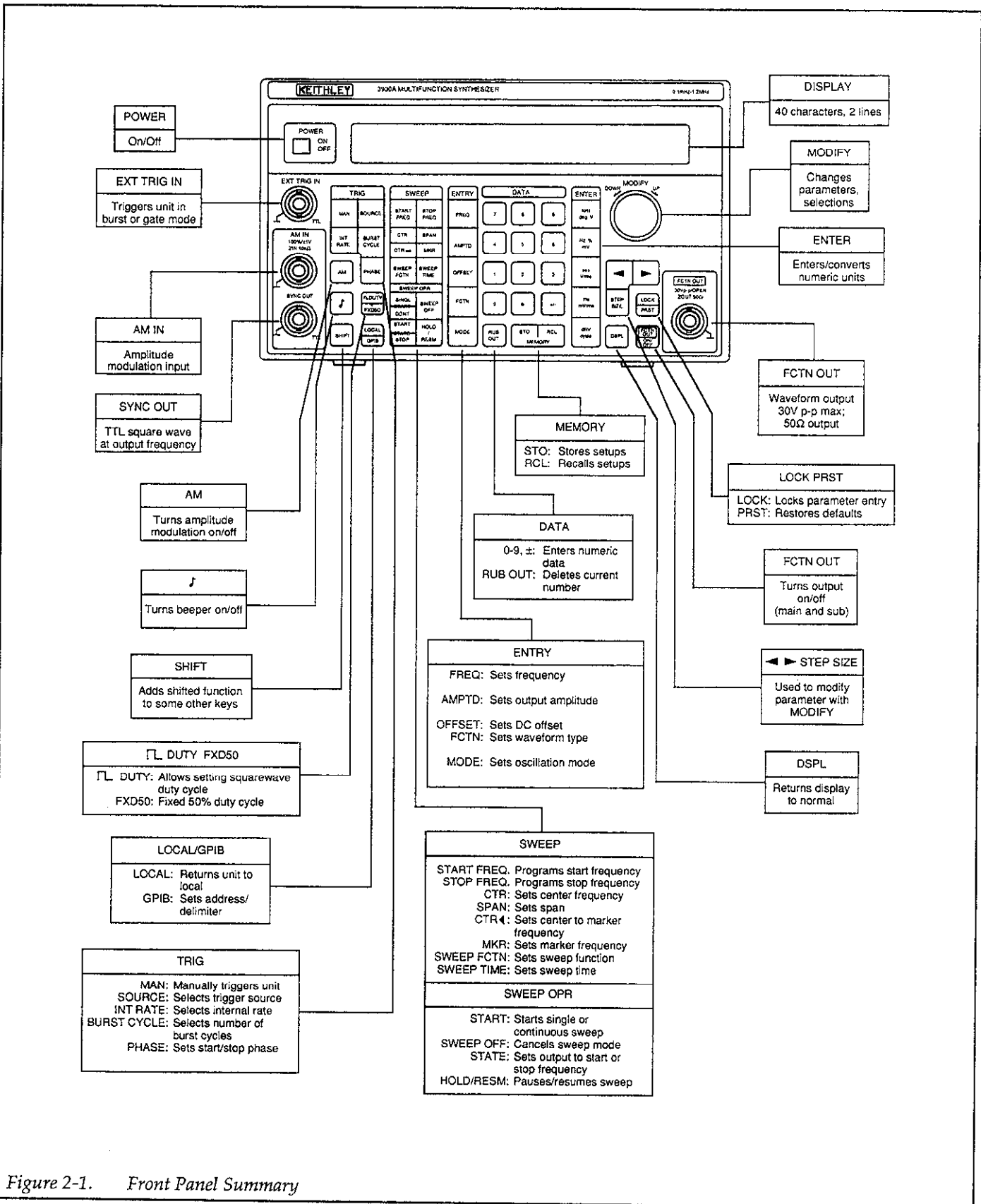

Figure 2-1. Front Panel Summary

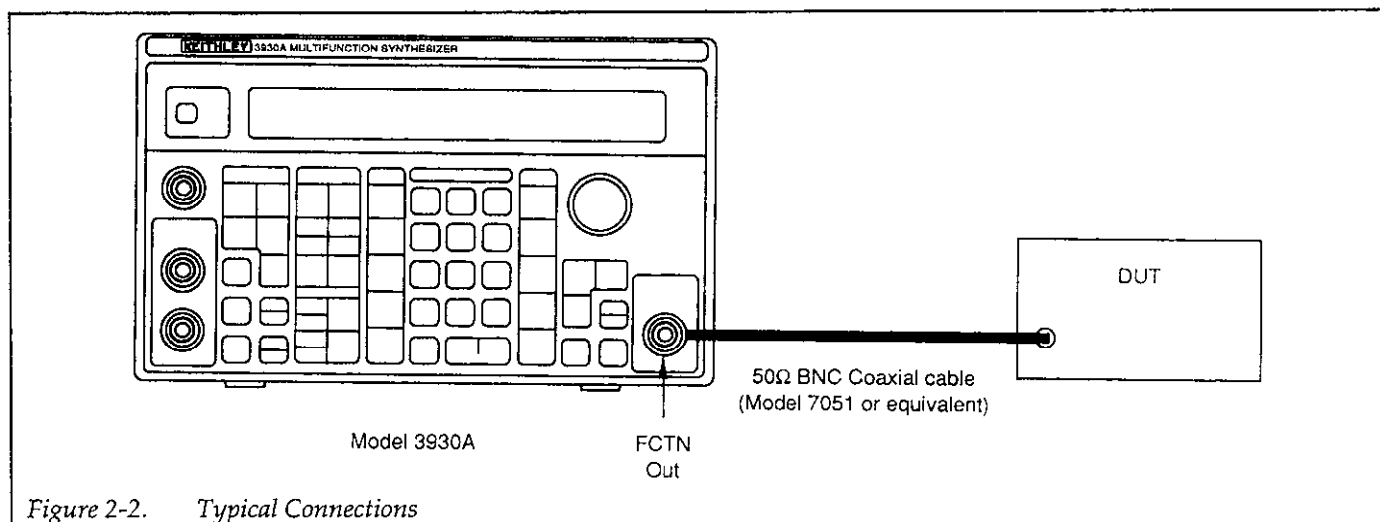

Figure 2-2. Typical Connections

2.5.3 Operating Examples

The following examples give step-by-step instructions for setting basic Model 3930A operating parameters. The Model 3930A can be connected to an oscilloscope to view the results of the various operating examples.

Example 1: Selecting the Waveform Type (Function)

The waveform type can be selected using the FCTN key as follows:

1. Press FCTN and note that the instrument displays the current function and the available functions.
2. Press the number key corresponding to the desired function (0-5), or rotate the MODIFY knob until the desired function number is displayed. For example, press 3 to select the square-wave function. The waveform will immediately change to the selected function.
3. Press DSPL to return to the normal display mode.

Example 2: Setting the Waveform Frequency or Period

Use FREQ to set the frequency or period of the output waveform as follows:

1. Press FREQ to enter the frequency-programming mode. The instrument will display the allowable frequency range (0.1mHz to 1.2MHz for sine waves, 0.1mHz to 100kHz for all other waveform types).

2. To directly enter a completely new numeric frequency value, key in the desired number followed by the appropriate units key (Hz or kHz). For example, to enter a frequency of 10.1kHz, press: 1 0 . 1 kHz.
3. To simply modify an existing frequency value, place the cursor on the digit to be changed using ◀ or ▶, then use the MODIFY knob to set the digit to the desired value. Repeat as necessary for all digits to be changed. Note that you can press the STEP SIZE key to change the increment, or to multiply or divide by 2 or by 10.
4. To display the time period of the waveform frequency, press the sec key. You can then key in a new time period or modify the existing period, if desired.
5. Press Hz or kHz to return to frequency display.
6. Press DSPL to return to normal display.

Example 3: Setting the Output Amplitude

Use the AMPTD key to set the output voltage amplitude as follows:

1. Press AMPTD, and note that the instrument displays the current amplitude and allowed amplitude range.
2. To enter a completely new amplitude value in p-p units, key in the numeric value, then press V or mV, as required. For example, to enter a 30mV p-p amplitude, press: 3 0 mV.
3. To simply modify the existing amplitude value, use the cursor keys and the MODIFY knob to set the value as required.
4. Press DSPL to return to normal display.

Example 4: Programming the DC Offset

The OFFSET key allows you to set the DC or average level of the output waveform, as in the following example:

1. Press OFFSET, and note that the instrument displays the current offset value and allowed range.
2. Either key in the desired offset, or use the MODIFY knob and cursor keys to change the value.
3. Press DSPL to return to normal display.

Example 5: Selecting the Operating Mode

The Model 3930A can be operated in continuous, burst, or gate modes. The operating mode can be set with the MODE key as in the following example:

1. Press MODE, and note that the instrument displays the current mode and available modes (continuous, burst, and gate).
2. Press the number of the desired mode (or rotate MODIFY to choose the desired operating mode).
3. Press DSPL to return to normal display.

Example 6: Controlling Sweep Operation

The Model 3930A can be used to sweep across a desired frequency range. The SWEEP keys allow you to program

sweep parameters, while the SWEEP OPR keys control sweep operation. Perform the steps below to demonstrate basic sweep operation:

1. Press START FREQ, and key in or use MODIFY to set the sweep start frequency. For example, press 1 kHz to program a 1kHz start frequency.
2. Press STOP FREQ, and set the sweep stop frequency as desired. For example, to program a 10kHz stop frequency, press 10 kHz.
3. Press CTR and SPAN to view the center and span frequencies. With 1kHz and 10kHz start and stop frequencies, the center and span frequencies will be 5.5kHz and 9kHz respectively. NOTE: If you change the center or span frequencies, the start and stop frequencies will be automatically changed accordingly.
4. Press SWEEP FCTN, and choose the type of sweep. For example, press 2 to select a linear, ascending sweep type.
5. Press SWEEP TIME, and program the sweep time as required. For example, press 5 sec to program a five-second sweep time.
6. To generate a single sweep, press SINGL START. The unit will generate one sweep based on selected sweep parameters.
7. To generate continuous sweeps, press SHIFT START CONT. The Model 3930A will generate sweeps continuously based on selected sweep parameters.
8. Press SWEEP OFF to stop a sweep.

SECTION 3

Operation

3.1 INTRODUCTION

This section contains detailed information on front panel operation of the Model 3930A. For detailed GPIB (IEEE-488 bus) operation, refer to Section 4.

3.2 FRONT PANEL AND REAR PANEL DESCRIPTION

3.2.1 Front Panel Description

The front panel of the Model 3930A is shown in Figure 3-1. The front panel is made up of a two-line, 40-character liquid crystal display and a control panel

with a built-in flat keyboard. The liquid crystal display presents information useful for the operation of the Model 3930A, such as the value of each parameter and the range of permissible parameter values.

The keyboard includes a SHIFT key, which gives certain other keys secondary functions. A key which is shaded with the same color as the SHIFT key requires that you press SHIFT first before accessing the function of that particular key.

Most settings are maintained in battery backed-up memory. As a result, the Model 3930A automatically assumes the previous settings when the power is first turned on.

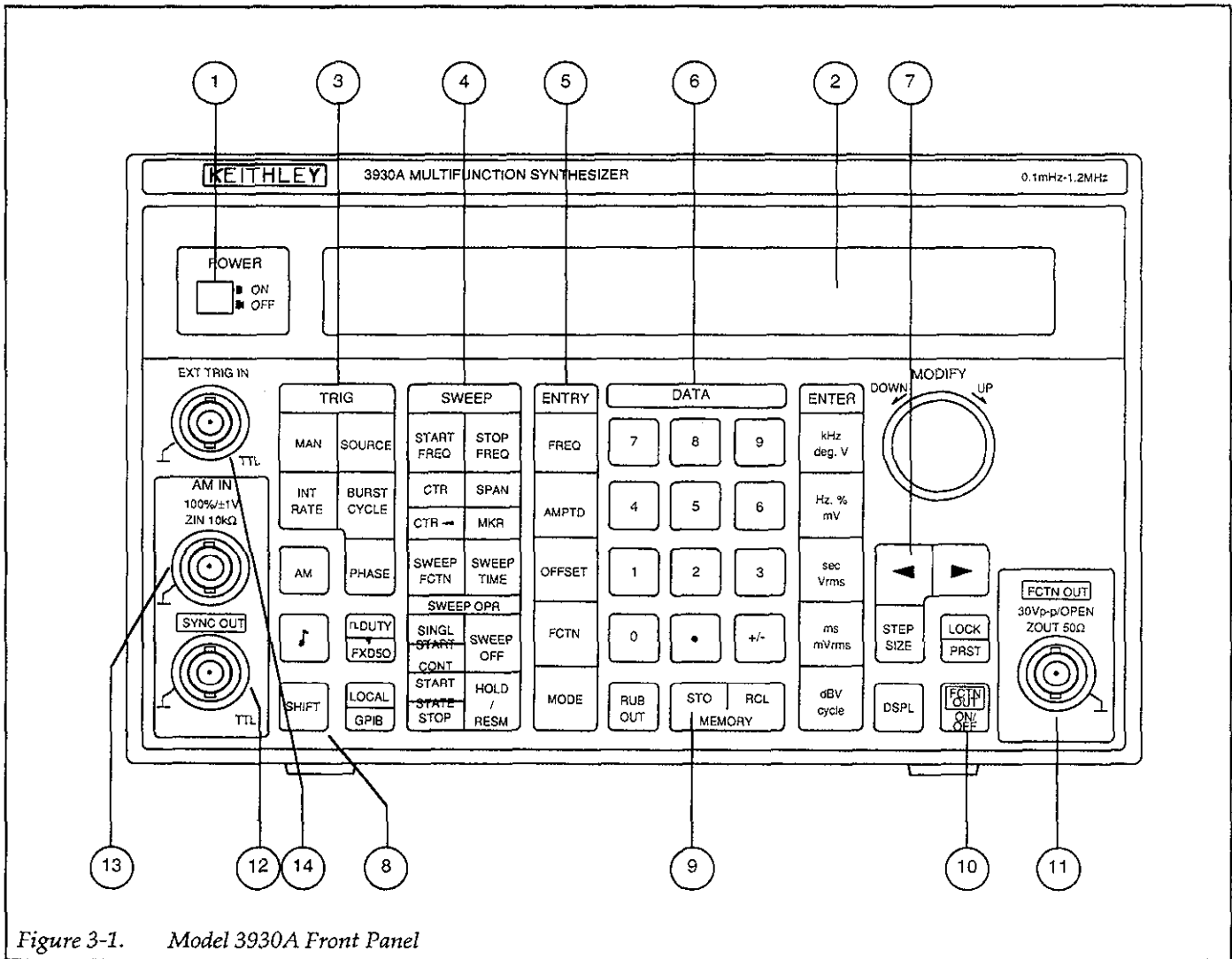

Figure 3-1. Model 3930A Front Panel

Key Representations

This section uses special representation such as [SHIFT], [MODIFY], or [SIZE] in the explanation of certain keys. This representation indicates the following:

[SHIFT] Press the applicable key after pressing the SHIFT key to access the shifted key function. The liquid crystal display indicates "SHIFT" in the upper left corner when the Model 3930A is in the shift mode.

[MODIFY] Key in the value using the DATA keys, or change a given setting value with the MODIFY knob. The up/down step size when incrementing or decrementing a value is fixed at 1, and the cursor position is also fixed.

[MODIFY] [SIZE] Key in the value using the DATA keys, or change a given setting value with the MODIFY knob. You can specify the digit to be modified by placing the cursor on the desired digit using ◀ or ▶. In addition, you can change the modify up/down increment using the STEP SIZE key.

Detailed Descriptions

Each front panel feature is described below. The circled number to the left of each description corresponds to the appropriate number shown in Figure 3-1.

1 POWER ON/OFF (Power switch)

POWER controls AC power to the Model 3930A. Press this switch once to turn power on, and press POWER a second time to turn power off.

2 Display

The two-line, 40-character display shows parameter values and other important information during operation. An active display also indicates that instrument power is turned on.

3 TRIG (Trigger keys for burst or gate oscillation)

The various TRIG keys are used for the burst or gate oscillation modes. The trigger mode can be programmed using the MODE key described below.

MAN (Manual trigger)

Press MAN to manually trigger the unit (the MAN key is operational only in the external trigger mode). In the burst oscillation mode, pressing this key will generate the trigger signal. In the gate oscillation mode, the gate signal remains on as long as MAN is pressed.

When the external (EXT) trigger source is selected, MAN will be disabled under either of the following conditions:

1. If ∇ is the selected trigger source polarity, and a low-level signal is applied to EXT TRIG IN.
2. If \blacktriangle is the selected trigger source, and a high-level signal is applied to EXT TRIG IN, or if the BNC jack is left disconnected.

To use only the MAN key as the trigger signal, select EXT ∇ (external) for the trigger source (SOURCE key), and disconnect the cable from the EXT TRIG IN BNC connector.

SOURCE (Trigger source)

[MODIFY]

This key allows you to select the trigger source, which includes EXT/INT (external/internal) and ∇ / \blacktriangle (falling edge/rising edge). Selecting EXT will enable front panel triggering through the EXT TRIG IN BNC connector and the MAN key. Selecting INT will enable the internal trigger generator, the rate of which is programmed with the INT RATE key.

In the gate oscillation mode, ∇ and \blacktriangle correspond to gate on at falling edge and gate on at rising edge, respectively.

INT RATE (Internal trigger rate)

[MODIFY] [SIZE]

The INT RATE key sets the rate of the internal trigger generator, which is enabled only for the gate and burst oscillation modes when the internal trigger source is selected.

The normal method of setting this parameter is to program the rate as a time period, and the al-

lowed rate ranges from 0.001msec (1µsec) to 2,999.9sec. You can also set the rate as a frequency, in which case the allowed frequency range is from 0.0004Hz to 1000.0kHz. When the rate is programmed as a frequency, the actual rate is set by rounding the reciprocal of the given frequency to the value closest to the allowed period (the reciprocal is truncated to eliminate the portion below the resolution). As a result, setting the rate as a frequency may result in significant errors when the reciprocal of the frequency is very small. For example, entering frequencies of either 1000.0kHz or 600.00kHz results in a 0.001msec period.

BURST CYCLE (*Number of burst cycles*)
[MODIFY] [SIZE]

The BURST CYCLE key allows you to program the number of burst cycles, which defines the number of waveform cycles generated in the burst oscillation mode. The allowed range of settings is from 1 cycle to 65,536 cycles. To use burst oscillation, select the burst oscillation mode with the MODE key.

PHASE (*Start/stop phase*)
[MODIFY] [SIZE]

The PHASE key allows programming of the start/stop phase setting for the burst or gate oscillation modes. The allowed phase range is from -360.0° to 360.0° with 0.1° resolution.

When the Model 3930A is used with the optional Model 3933A Phase Shifter to form a multiphase oscillator, the phase setting is the phase offset for the Model 3933A.

NOTE

In the burst or gate oscillation modes, oscillation may be unstable if the next trigger is applied at approximately the same time the previous oscillation cycle ends. In this situation, set the Model 3930A temporarily to another oscillation mode, then return it to the desired mode. Doing so will restore normal operation.

4 **SWEEP** (*Frequency sweep keys*)

The various SWEEP keys are used to program sweep functions such as start and stop frequency, center and span frequencies, and sweep

function and sweep time. The paragraphs below summarize the operation of these keys. Refer to the specifications located in Appendix B for details on the sweep range.

Note that frequency parameters can also be set using waveform period. See the discussion on the ENTRY keys (**5**) for information on frequency and period setting.

START FREQ (*Start frequency*)
[MODIFY] [SIZE]

The START FREQ key allows you to set the start frequency of the frequency sweep. You can specify a start frequency that is either higher or lower than the stop frequency. The relationship between the start and stop frequency values determines the sweep direction. If the start frequency is higher than the stop frequency, the sweep will be performed in a descending direction. If the start frequency is lower than the stop frequency, the sweep will be performed in the ascending direction.

If the start frequency is changed, the sweep range will be determined by the new start frequency and the current stop frequency.

STOP FREQ (*Stop frequency*)
[MODIFY] [SIZE]

The STOP FREQ key allows you to set the stop frequency of the frequency sweep. You can specify a stop frequency that is either higher or lower than the start frequency. If the stop frequency is higher than the start frequency, the sweep will be performed in ascending order. If the stop frequency is lower than the start frequency, the sweep will be performed in descending order.

If the stop frequency is changed, the sweep range will be determined by the new stop frequency and the current start frequency.

CTR (*Center frequency*)
[MODIFY] [SIZE]

The CTR key allows setting of the center frequency of the frequency sweep. The center frequency is specified as the center frequency for the linear scale, and is not the sweep time basis center frequency for LOG sweep.

The relationship between the current start and stop frequency values determines the sweep direction. If the center frequency is changed, the start and stop frequencies will be changed, but the span frequency will remain constant, and the sweep direction will remain unchanged.

CTR ◀ (*Substitution of marker frequency for center frequency*)
[SHIFT]

The CTR ◀ key substitutes the marker frequency for the center frequency. The span frequency is affected in the same manner as when using the center frequency setting. If the substituted marker frequency is different than the center frequency, the start and stop frequencies will change accordingly.





SPAN (*Frequency span*)
[MODIFY] [SIZE]

This key allows you to set the frequency span of the frequency sweep. The relationship between the start and stop frequency values determines the sweep direction. If the frequency span is changed, the start and stop frequencies will be changed so that the sweep range is determined by the new frequency span and the current center frequency, which will not change.

MKR (*Marker frequency*)
[SHIFT], [MODIFY] [SIZE]

This key allows you to set the marker frequency of the frequency sweep. Note that you can specify only one marker frequency. While the oscillation frequency is higher than the programmed marker frequency during a sweep, the marker output signal available at the rear panel MKR OUT jack will be set low. The marker output signal will be set high at all other times.

SWEEP FCTN (*Sweep function*)
[MODIFY]

The SWEEP FCTN key allows you to select the sweep function. Available sweep functions include: step () , linear triangular wave and sawtooth wave ( or ), and log triangular wave or sawtooth wave ( or ).

With the step sweep function, the output frequency simply changes between the start frequency and stop frequency at intervals determined by the sweep time. With the linear and log functions, the frequency increases or decreases linearly or logarithmically, respectively.

SWEEP TIME (*Sweep time*)
[MODIFY] [SIZE]

The SWEEP TIME key allows you to set the sweep time, which is the time period from the start frequency to the stop frequency. The allowed sweep time range is from 5msec to 9,999sec. For log sweeps, the minimum sweep time is 5.16msec per decade.

SWEEP OPR (*Sweep Operation*)

SINGL START (*Single start: single-sweep start*)

This key starts a single sweep. Only one sweep per key press will be generated.

CONT START (*Continuous start: repeated sweep start*)
[SHIFT]

This key starts repeated sweeps, which will be generated continuously until halted with the HOLD or SWEEP OFF keys.

SWEEP OFF (*Sweep off*)

SWEEP OFF cancels the sweep mode. The oscillation frequency remains at the current frequency when this key is pressed, and the MKR OUT, SWEEP SYNC OUT, and X DRIVE OUT signals on the rear panel are set to high level, high level and 0V, respectively.

START STATE (*Start state: start frequency output*)

This key resets the sweep and sets the output frequency to the start frequency.

When START STATE is pressed, the MKR OUT and SWEEP SYNC OUT signals on the rear panel are set high. The X DRIVE OUT signal is set to 0V when the start frequency is lower than the stop frequency; the X DRIVE OUT signal is set to 10V when the start frequency is higher than the stop

frequency. These signals can be used for scale adjustments of XY recorders.

STOP STATE (*Stop frequency output*)
[SHIFT]

STOP STATE performs the opposite function of the START STATE key in that it sets the output frequency to the stop frequency.

When STOP STATE is pressed, the MKR OUT and SWEEP SYNC OUT signals on the rear panel are set high. The X DRIVE OUT signal is set to 0V when the start frequency is higher than the stop frequency; it is set to 10V when the start frequency is lower than the stop frequency.

HOLD/RESM (*Hold/resume: temporary stop and resume*)

This key alternately stops and resumes the sweep.

Pressing HOLD/RESM while sweep is in progress will halt the sweep with the frequency, MKR OUT, SWEEP SYNC OUT, and X DRIVE OUT signals present at that time maintained at their present values. Pressing HOLD/RESM with the sweep halted resumes the sweep with signal conditions previously present maintained.

5

ENTRY (*Main parameter setting keys*)

FREQ (*Frequency*)
[MODIFY] [SIZE]

The FREQ key allows you to set the output frequency of the unit. The allowed frequency range is between 0.0001Hz and 1,200kHz (1.2MHz) for the \sim and \square waveforms (with 50% fixed duty cycle); the range is from 0.0001Hz to 100kHz for all other waveforms. Note that the 100kHz restriction for the \square waveform applies only with a variable duty cycle; you can set the frequency to a maximum of 1,200kHz with a 50% fixed duty cycle. Also, you can set the frequency to a maximum of 1,200kHz with the \wedge , \nearrow , and \searrow waveforms if the quality of the waveform is unimportant.

The oscillation frequency can be programmed in frequency units or time period units. The al-

lowed range for period units is from 0.00084msec to 10,000.0sec (1,200kHz limit) or from 0.01000msec to 10,000.0sec (100kHz limitation). For period-based settings, the frequency is set to the value of the reciprocal that is rounded to the nearest number below 0.1mHz. Therefore, period-based setting will cause significant errors when the number of digits for the value of the reciprocal that is rounded is small. For example, values of either 10,000.0sec or 6,000.00sec will result in a frequency of 0.0001Hz.

If you press FREQ during sweep operation or during sweep hold, the current frequency will be displayed, but you will not be able to change the frequency.

Note that the phase of the waveform is continuous even when the frequency is changed.

AMPTD (*Amplitude*)
[MODIFY] [SIZE]

Pressing AMPTD allows you to set the output amplitude of the unit. The allowed amplitude when the DC offset is 0V ranges from 0.30mVp-p to 30.00Vp-p when the output range mode is set to automatic (AUTO), or from 0V to 30.00Vp-p when the output range mode is fixed (FXD). When the DC offset is not 0V, the upper and lower limits are restricted (see specifications in Appendix B). The values for the amplitude setting are for no-load (open) output conditions.

When the output range mode is AUTO, the amplitude setting can be specified using rms or dBV units in addition to using p-p units. You can specify the appropriate units by pressing the appropriate ENTER units key when entering the amplitude. Use mV or V for p-p values, mVrms or Vrms for rms values, or dBV for dB values.

Note that p-p values are the only permissible units for DC waveforms, and that the p-p value varies from one waveform to another if you specify the amplitude as an rms or dBV value. Also note that the amplitude set by the AMPTD key is the amplitude of an AC waveform. Set the amplitude of a DC waveform type with the OFFSET key.

OFFSET (*DC offset*)
[MODIFY] [SIZE]

The OFFSET key enables DC offset voltage programming. The allowed offset is between -15V and 15V for a DC waveform. For other waveform

types, the offset range is restricted to the values given in the specifications (Appendix B and paragraph 3.5.7). All specified offset ranges are for no-load (open-circuit) conditions.

FCTN (*Function: waveform*)
[MODIFY]

This key allows you to choose the output waveform. Available waveforms include: DC, SIN (sine wave), \wedge (triangular wave), \square (square wave), \nearrow (ascending sawtooth wave), and \searrow (descending sawtooth wave).

When the output range mode is AUTO, and the waveform function is changed, the amplitude of the new waveform is automatically changed to p-p units, unless the new waveform is DC. For details, refer to paragraph 3.5.8 in Section 3.

MODE (*Oscillation mode*)
[MODIFY]

The MODE key programs the oscillation mode setting. Available oscillation modes include: CONT (continuous oscillation), BRST (burst oscillation), and GATE (gate oscillation). Refer to paragraph 3.5.9 for details in Section 3.

6

DATA (*Numeric keys for parameter entry*)

The DATA key set consists of numeric keys for entering a value and ENTER (units) keys for setting the units of the entered value. The . (decimal point) key and the +/- (sign inversion) key do not affect parameters for which they have no function.

Parameters that are selected with one numeric character, such as waveform function and oscillation mode, do not require that any ENTER key be pressed. Such parameters are set simply by entering one numeric character (or by rotating the MODIFY knob as required).

For other parameters, enter the required value with the numeric keys, then press the appropriate ENTER units key. If you enter the incorrect value, press the RUB OUT (delete) key. RUB OUT deletes the numeric character or decimal point from the rightmost position. To delete the entire entered value and return the display to the

current value, press the original function key to enable parameter entry for that function.

For frequency and amplitude where parameters can be entered in different types of units, select the appropriate units key from the ENTER keys to complete entry of the value. Use the deg, %, or cycle keys to enter phase, duty cycle, or burst cycles respectively.

The units keys also have a units-conversion function. This feature is available for unit conversions such as frequency-to-period conversion for frequency, as well as amplitude p-p/rms/dBV conversions. When the units key is pressed with the current setting displayed, the display will be changed to reflect the newly-selected units; note, however, that the actual output remains unchanged.

0 (*Output range mode*)
[SHIFT], [MODIFY]

Pressing SHIFT 0 enables output range mode selection and allows you to choose between automatic (AUTO) and fixed (FXD). For complete details on output range modes, refer to paragraph 3.5.12 in Section 3.

7

MODIFY (*Modify operation keys*)

In addition to using the numeric keys, you can set any parameter except the GPIB address, delimiter, and memory number by using the MODIFY knob. The MODIFY knob is operational when the Model 3930A is in the appropriate parameter-entry mode, and the unit displays the current parameter value.

MODIFY (*Modify knob*)

When the step size is ± 1 or ± 5 , you can select the digit to increase or decrease by 1 or by 5 by placing the cursor under the appropriate digit (use \blacktriangleleft or \blacktriangleright) and turning the MODIFY knob to the right or left.

When the step size is $\times 2$, you can divide the selected parameter by 2 by turning knob counterclockwise, or multiply the parameter by 2 by turning the knob clockwise. Similarly, when the step size is $\times 10$, you can divide or multiply the parameter by 10 by rotating the knob counterclockwise or clockwise respectively. Note that

the cursor will not be displayed when the step size is $\times\div 2$ or $\times\div 10$.

◀ (Left cursor)

This key moves the cursor to the left by one digit each time it is pressed. Note that cursor will not be displayed when the step size is $\times\div 2$ or $\times\div 10$.

▶ (Right cursor)

This key moves the cursor to the right by one digit each time it is pressed. Note that cursor will not be displayed when the step size is $\times\div 2$ or $\times\div 10$.

STEP SIZE (UP/DOWN step size)

STEP SIZE changes the MODIFY knob UP/DOWN step size. For parameters with values that can be changed using variable step sizes, the step size will change in the following order each time this key is pressed: ± 1 ± 5 $\times\div 2$ $\times\div 10$...

When the step size is ± 1 or ± 5 , the digit indicated by the flashing underline cursor changes by 1 or by 5 when the MODIFY knob is rotated. When the step size is $\times\div 2$ or $\times\div 10$, the cursor disappears, and the entire display value can be divided or multiplied by 2 or by 10 by rotating the MODIFY knob.

8

Miscellaneous Keys

AM (Amplitude modulation)
[MODIFY]

The AM key allows you to turn amplitude modulation on or off (1= on; 0=off). Note that the modulation signal is applied to the front panel AM IN BNC jack. When the modulation signal is 0V, or when the modulation depth is 0%, turning on amplitude modulation reduces the p-p amplitude of the output waveform to one-half its normal value (the value when amplitude modulation is turned off). The output amplitude is the normal, displayed amplitude value when the modulation depth is 100%. Refer to paragraph 3.5.6 for more information.

♯ (Beep sound)
[MODIFY]

This key controls the beep that sounds when you press front panel keys and when errors occur. You can turn the beep OFF (0) or ON (1).

▭ DUTY (Square-wave duty cycle)
[MODIFY] [SIZE]

The ▭ DUTY key allows you to program the square-wave duty cycle. The allowed duty cycle ranges from 5.0% to 95.0%.

Two duty-cycle modes are available: 50% fixed and variable. In the variable mode, the upper frequency limit for square waves is restricted to 100kHz even if the duty cycle is set at 50%. Refer to paragraph 3.5.8 for details.

FXD50 (Fixed 50% duty cycle)
[SHIFT]

This key fixes the square-wave duty cycle at 50%. The upper frequency limit for square waves is 1.2MHz when the duty cycle is fixed at 50%. See paragraph 3.5.8.

SHIFT

The SHIFT key adds a secondary function to many other front panel keys. Those keys that have shifted functions have those functions represented on the lower part of each key using the same color as the SHIFT key. Keys with shifted functions include CTR ◀, MKR, GPIB, FXD50, and PRST.

When the SHIFT key is first pressed, the unit enters the shift mode, and the liquid crystal display indicates "SHIFT" in the upper left corner. The shift mode is canceled when any key including the SHIFT key is pressed (if a key with a shift function is pressed, the unit enters that mode; otherwise, it returns to the mode it was in before SHIFT was pressed).

LOCAL (Return to local)

LOCAL cancels remote and returns the instrument to the local mode when used over the GPIB. When the instrument is in remote (as indicated by "RMT" in the upper left corner of the display), parameter setting is disabled, but you can still display parameters by pressing appropriate front panel keys.

GPIB (*GPIB Address: GPIB address, delimiter*)
[SHIFT]

The GPIB key allows you to program the GPIB primary address and the output delimiter used when the Model 3930A is acting as a GPIB talker. Only the numeric keys can be used for setting these parameters (the MODIFY knob cannot be used). The allowed range for the primary address is from 0 to 30, and the delimiter can be selected for CR/LF or CR (CR and LF or CR only).

The GPIB primary address is the integer part of this parameter, and the delimiter is defined by the fractional part. For example, a parameter of 2.0 indicates a primary address of 2 and defines CR/LF as the delimiter. Similarly, a parameter of 4.1 indicates a primary address of 4 with CR as the delimiter.

To change only the primary address, enter only the integer part of the number; the delimiter will remain unchanged. To change only the delimiter, enter the decimal point followed by the fraction (0 or 1); the primary address value will remain unchanged.

When programming the primary address and/or delimiter, remember that you must press any one of the ENTER keys to complete the entry process.

9

MEMORY (*Memory operation keys*)

The MEMORY keys allow you to store and recall instrument setups. Ten units of memory, numbered 0 through 9, are available for setup storage.

STO (*Store: store setup in memory*)

The STO key stores the current instrument setup parameters in the selected memory location (0-9). You can use only numeric keys to store setups (the MODIFY knob cannot be used). Pressing the numeric key will immediately store the current parameter values and erase the previous setup in the selected memory location.

RCL (*Recall: read setup from memory*)

RCL reads instrument setups from the desired memory location (0-9). You can use only numeric keys for selecting memory locations to recall (the MODIFY knob cannot be used). Pressing the nu-

meric key will immediately read the contents of the selected memory location and will change the current instrument settings accordingly.

Refer to paragraph 3.5.12 for additional information on instrument settings after memory recall.

10

Additional Keys

LOCK (*Lock out front panel keys*)

This key allows you to disable parameter setting via most front panel keys. Available modes are ON (1) and OFF (0). When the lock is ON, the parameters associated with most front panel keys cannot be programmed, and the corresponding operating modes cannot be changed. However, LOCK, DSPL, and FCTN OUT ON/OFF are still operational when the lock is ON. In addition, trigger input and sweep control input from appropriate BNC connectors are still enabled.

Current parameter values such as frequency can be displayed by pressing appropriate keys when the lock is ON. The liquid crystal display will indicate "LOCK" in the position where the modification step size is normally indicated. Also, parameter names will not flash, and the cursor will not be displayed.

PRST (*Preset*)
[SHIFT]

The PRST key recalls the factory default preset operating parameters. Refer to the specifications in Appendix B for a summary of preset parameter settings.

DSPL (*Main parameter display*)

DSPL displays the following main parameters simultaneously: Signal output ON/OFF (blank for ON), frequency, amplitude, amplitude modulation mode (AM for on, blank for off), DC offset, waveform function, oscillation mode, and sweep mode (blank for normal oscillation). Note that parameters cannot be programmed from the main parameter display; you must press appropriate keys before setting parameters.

FCTN OUT ON/OFF (*Signal output ON/OFF*)

FCTN OUT turns the output waveform off or on. Each time this key is pressed, ON/OFF will toggle to the opposite state.

When FCTN OUT is OFF, the main output signal is turned off and open-circuited, but the SYNC OUT signal is not affected and remains on.

The liquid crystal display indicates "OFF" in the upper left corner when the Model 3930A is in the FCTN OUT OFF mode (except in the SHIFT or REMOTE modes).

Note that the factory default setting for FCTN OUT is ON at power on.

11 FCTN OUT (*Function output: waveform output*)
This BNC jack provides the waveform output signal. The maximum output voltage range is $\pm 15\text{V}$ /open circuit, and the output impedance is 50Ω .

12 SYNC OUT (*Synchronous output*)
This BNC jack provides a TTL-level square wave signal at the same frequency as the main function output waveform. Note that the duty cycle of this signal is affected by the variable duty cycle

setting when the square-wave function is selected.

13 AM IN (*Amplitude modulation input*)

The BNC jack is used to apply an external amplitude modulation signal. 100% modulation occurs with a $\pm 1\text{V}$ input signal, and the input impedance is $10\text{k}\Omega$.

14 EXT TRIG IN (*External-trigger input*)

This BNC connector is an input for external TTL-level signals, which can be used to trigger the Model 3930A.

EXT TRIG IN is internally pulled up to a high logic level, which means that the external trigger input will remain high with no input signal connected. If the EXT Δ trigger source is selected with the unit in the gate oscillation mode, the gate signal will be enabled, and the unit will effectively be in the continuous oscillation mode with no external trigger input signal applied.

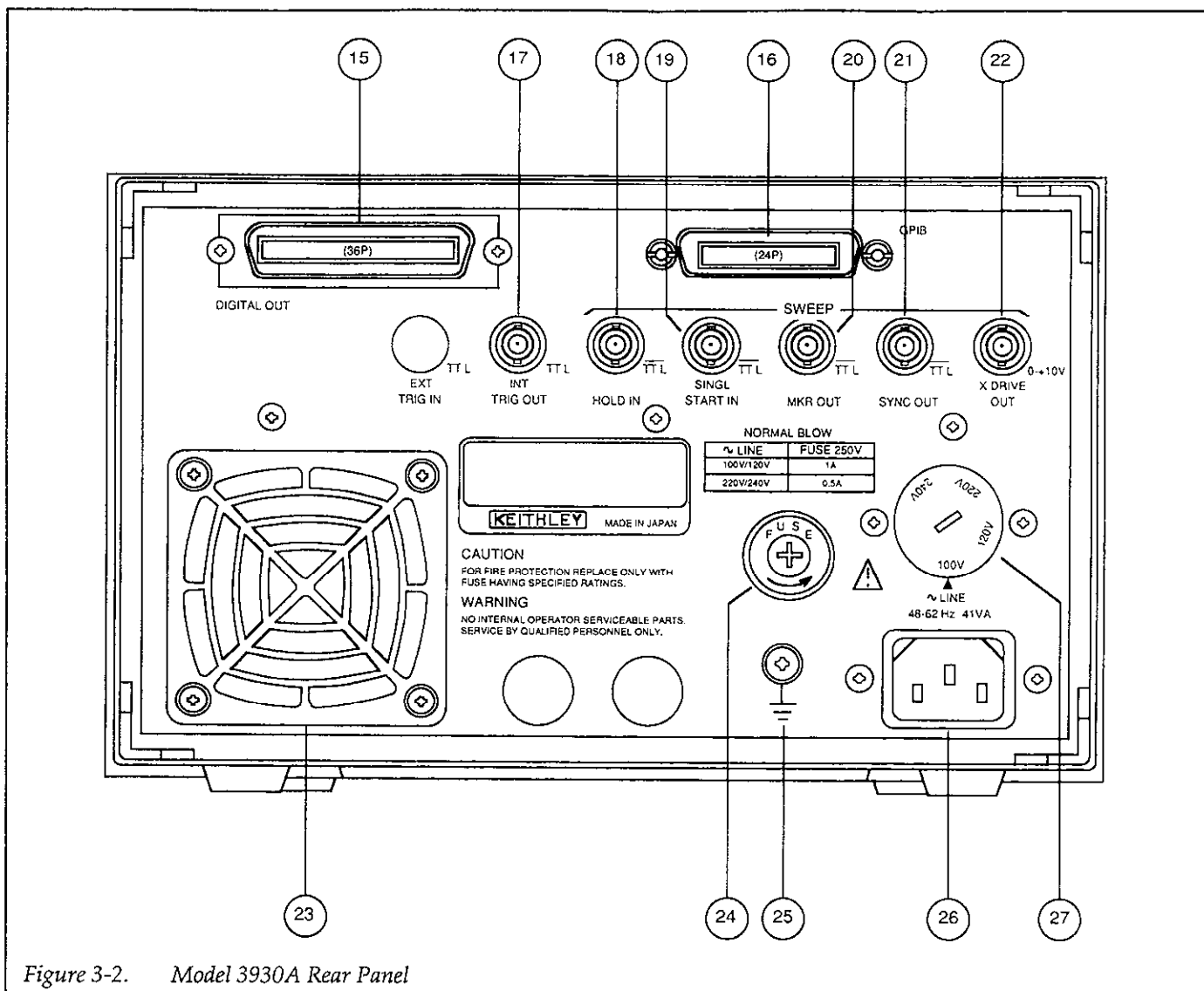

Figure 3-2. Model 3930A Rear Panel

3.2.2 Rear Panel Description

The following paragraphs describe the various aspects of the Model 3930A rear panel, which is shown in Figure 3-2.

- 15 **DIGITAL OUT** (*Digital output*)
DIGITAL OUT is a 36-pin connector used to connect the Model 3930A to the optional Model 3933A Phase Shifter to form a multiphase oscillator.
- 16 **GPIB** (*General Purpose Interface Bus connector*)
This connector is the 24-pin connector use to connect the Model 3930A to the GPIB (IEEE-488 bus). Shielded GPIB cables, such as the Model 7007, are recommended for bus connections. The primary address and output delimiter are set with the GPIB key.
- 17 **INT TRIG OUT** (*Internal trigger output*)
This BNC connector provides a TTL-level trigger output signal. When the external trigger source is used, the signal applied to the EXT TRIG IN jack is output. When the internal trigger source is selected, the internal trigger oscillator signal is output.
- 18 **SWEEP HOLD IN** (*Sweep hold input*)
This BNC connector accepts a TTL-level signal used for sweep hold input. The sweep is halted as long as the input signal is at a low logic level.
- 19 **SWEEP SINGL START IN** (*Single-sweep start input*)
This BNC connector accepts a TTL-level signal used to start a single sweep. A single sweep starts at the falling edge of the input signal.
- 20 **SWEEP MKR OUT** (*Sweep marker output*)
This BNC connector provides a TTL-level signal used for sweep marker output. This signal goes low when the frequency rises above the marker

frequency during a sweep, and it remains high at all other times.

- 21 **SWEEP SYNC OUT** (*Sweep synchronous output*)
This BNC connector provides a TTL-level signal for sweep synchronous output. This signal is at low level while a sweep from the start frequency to the stop frequency is in progress; it is at a high level at all other times.
 - 22 **SWEEP X DRIVE OUT** (*Sweep X-axis drive output*)
This BNC connector provides the signal for sweep X-axis drive output. The output voltage ranges from 0V to 10V, and it increases and decreases according to the sweep direction as the sweep is generated. This output signal is intended for use as the X-axis drive for an oscilloscope or XY recorder.
 - 23 **Air intake port**
An air intake port is provided on the rear panel for the fan that provides cooling. Allow at least four inches of clearance behind the port when installing the unit near a wall or other rear obstruction.

When the air filter becomes dirty, remove the air filter cover, and clean the filter with pressurized air or wash it with a mild detergent. Make sure that the filter is completely dry before installing it back in the unit. The filter should be cleaned at least once every three months in a clean environment, or at least once a month in a dirty environment.
- CAUTION**
- Immediately turn off the power to the unit if the fan ceases to operate. Be careful not to obstruct the exhaust ports on the upper and lower panels. Failure to observe these precautions may result in instrument damage.
- 24 **FUSE**
The fuse protects the main AC power line input. The fuse can be replaced by disconnecting the line cord and unscrewing the fuse holder. Replace only with the type indicated below.

Line Voltage	Fuse Current Rating
110V, 120V	1A
220V, 240V	1/2A

NOTE: fuses are 5 × 20mm and have 250V, normal blow ratings.

25  (Grounding terminal)

The grounding terminal is connected to the chassis of the Model 3930A. To prevent interference and for safety, be sure to ground this terminal.

WARNING

If the Model 3930A is connected to an ungrounded AC outlet, connect the grounding terminal to safety earth ground using #18AWG minimum wire before use.

26 LINE (Power input connector)

The LINE connector is used to connect the instrument to AC power.

WARNING

To avoid the possibility of electric shock, connect the Model 3930A to grounded AC outlet using the supplied 3-wire power cord or the equivalent.

27 LINE Voltage Selector (Supply voltage switch)

This switch sets the Model 3930A for the correct line voltage. Using a flat-blade screwdriver, set the switch in the proper position for the supply voltage in your area.

WARNING

Disconnect the line cord before changing setting the switch position.

CAUTION

Operation the Model 3930A on an incorrect line voltage may result in instrument damage.

3.3 Input and Output Connections

3.3.1 Input Connections

Four signals are applied to the BNC connectors of the Model 3930A. The specifications of the input signals are given below.

CAUTION

Be careful not to exceed the maximum allowable input voltages, or instrument damage may occur.

Logic Inputs

Logic inputs include EXT TRIG IN (external trigger input), SWEEP SINGL START IN (single-sweep start input), and SWEEP HOLD IN (sweep hold input). Key specifications for these inputs include:

Input voltage: TTL level

Maximum allowable input voltage: 0V to +5V

Circuit: See Figure 3-3, Logic Input Circuits.

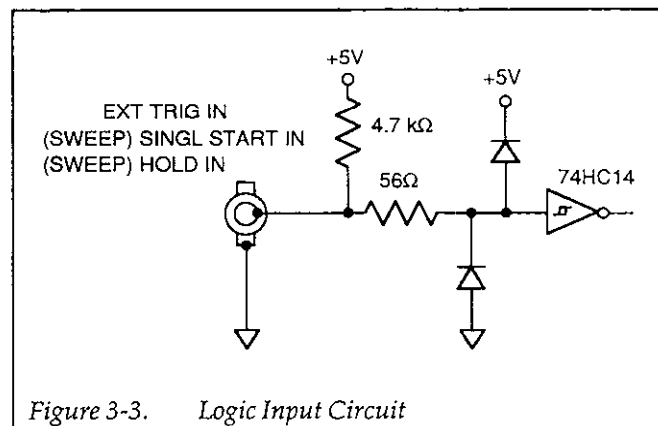

Figure 3-3. Logic Input Circuit

Analog Input

The AM IN jack can be used to apply an external analog signal which is then used to amplitude modulate the output signal. Important specifications are summarized below.

Input voltage range: -3V to +1V

Allowable maximum input voltage: ±15V

Input frequency range: DC to 100kHz

Input impedance: 10kΩ

Circuit: See Figure 3-4, Amplitude Modulation Input Circuit

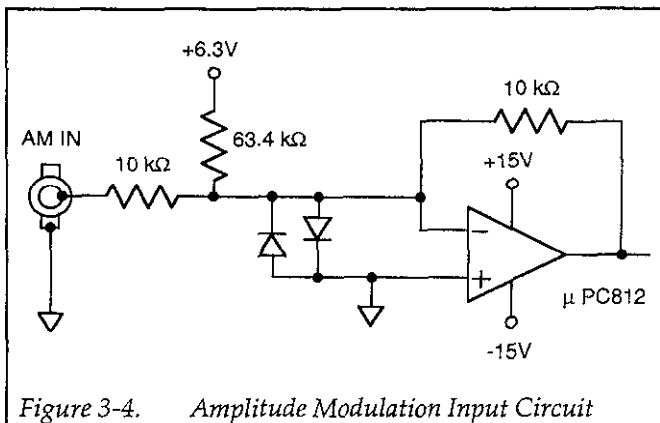

Figure 3-4. Amplitude Modulation Input Circuit

3.3.2 Output Connections

Six output signals are available from various BNC connectors of the Model 3930A. The specifications for the output signals are given below.

CAUTION

Be careful not to connect an external signal to an output connector, or instrument damage may occur.

Logic Outputs

Logic outputs include SYNC OUT (synchronous output), INT TRIG OUT, internal trigger output), SWEEP MKR OUT, (sweep marker output), and SWEEP SYNC OUT (sweep synchronous output). Specifications for these outputs are summarized below.

Output voltage: TTL level

Circuits: See Figure 3-5, Figure 3-6, and Figure 3-7

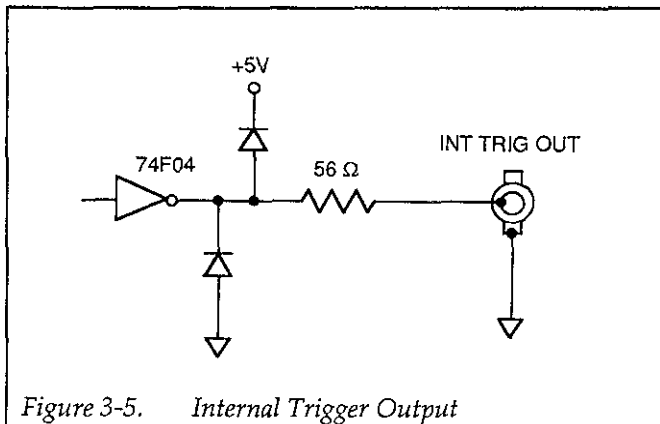

Figure 3-5. Internal Trigger Output

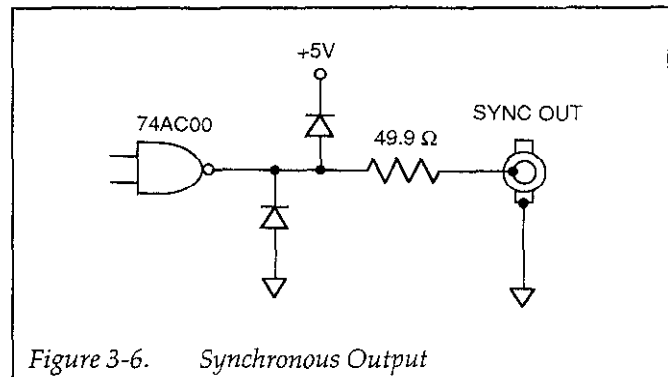

Figure 3-6. Synchronous Output

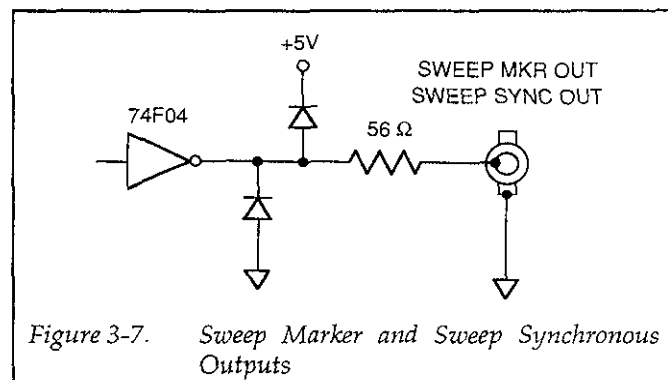

Figure 3-7. Sweep Marker and Sweep Synchronous Outputs

Analog Outputs

FCTN OUT (Main Waveform Output)

Maximum output voltage: $\pm 15\text{V}$ /open circuit,
 $\pm 7.5\text{V}/50\Omega$ load

Output impedance: 50Ω

Recommended load impedance: 50Ω or more

Short circuit protection

SWEEP X DRIVE OUT (Sweep X Axis Drive Output)

Output voltage: 0V to $+10\text{V}$ ($\pm 5\%$)/open circuit

Output impedance: 600Ω

Recommended load impedance: $10\text{k}\Omega$ or more

Output Considerations

All logic outputs are driven by 74F- or 74AC-type logic. Be careful not to connect a load that results in exceeding the drive capability of this type of TTL IC. Also, do not use excessively long connecting cables, as the resulting capacitance may have detrimental effects on the output signals.

The internal trigger output (INT TRIG OUT) and synchronous output (SYNC OUT) impedances are matched at 50 Ω at higher frequencies. Relatively good waveforms will be obtained if 50 Ω coaxial cables are used; however, cables connected to these outputs must not be terminated with a 50 Ω impedance.

The main waveform output (FCTN OUT) impedance is 50 Ω . To maintain maximum amplitude across the entire bandwidth, and for maximum square-wave quality, use a 50 Ω coaxial cable for connections, and terminate the opposite end of the cable with a 50 Ω impedance. Note that the Model 3930A displays voltage amplitude for open-circuit conditions. The actual output voltage with a 50 Ω termination is about half that for no-load conditions (about -6dB).

3.4 STARTUP

1. Check that the supply voltage switch is set at the proper position for the supply voltage. The allowable supply voltage range is $\pm 10\%$ of the voltage at which the supply voltage switch is set.

CAUTION

Operating the Model 3930A in an incorrect line voltage may result in damage to the unit.

2. Make sure that the power is off, then plug the supplied power cable firmly into the LINE connector on the rear panel of the Model 3930A. Insert the power plug into a grounded AC power receptacle.

WARNING

To avoid the possibility of electric shock, use only grounded AC receptacles for power connections.

Turn on Model 3930A power by pressing in on the front panel POWER switch. Power is ON when the POWER switch button is depressed (in); power is OFF when the POWER switch button is released (out). When the power is turned on, the Model 3930A will begin normal operation, and the liquid crystal display backlight will turn on.

3. When the power is first turned on, the Model 3930A will return to the previous settings effective prior to power-off, and the unit will display the main parameters.

If the previous settings were not stored correctly, the error code "Er MEMO11" will be displayed, and the preset settings will be placed into effect. At this point, main parameters will be displayed, and the settings prior to preceding power-off will be lost. This situation occurs when the backup battery used to maintain memory has insufficient charge, and stored data cannot be maintained. A fully-charged battery can retain memory for approximately 60 days. This time period, however, varies slightly with ambient temperature and from one battery to another. Approximately 50 hours are required to fully charge a dead battery.

When the battery becomes too weak for practical use, contact your Keithley representative or the factory for information on obtaining a replacement.

4. The backup battery may be discharged when the Model 3930A is used for the first time after being purchased, or if the unit has not been turned on for a considerable length of time. Turn the unit on for at least several hours to charge the battery.
5. Sweep operation mode parameters are not stored when the power is turned off. Therefore, turning the power off during sweep operation, sweep hold, end of single sweep, start frequency output, or stop frequency output, will result in a sweep-off state the next time power is turned on.

The function output on/off state is also not saved. The factory default setting at power-on is function output on.

6. If, at power on, the Model 3930A does not enter the mode with settings that were effective immediately before previous power-off (or the preset operating modes), or if the main display does not appear, contact your Keithley representative or the factory to determine the correct course of action.

NOTES:

1. Wait for at least five seconds before turning on the Model 3930A after turning it off.
2. For precise measurement applications, allow the Model 3930A to warm up for at least 30 minutes to allow internal circuits to stabilize.



3.5 OPERATING PROCEDURES



3.5.1 Setting Parameters Using Numeric Keys

When the appropriate parameter key such as **FREQ**, **AMPTD**, **OFFSET**, or **PHASE** is pressed, the parameter name and the present parameter value will be indicated in the upper part of the liquid crystal display. The allowed range of the parameter setting and useful help information will appear in the lower part of the display.

The parameter value can be changed when the parameter name indicated in the upper part of the liquid crystal display is flashing. The parameter name will not flash when the unit is in the GPIB remote mode, or when the front panel lock is on.

Parameters that are selected by pressing one numeric character (such as waveform function, oscillation mode, and trigger source), can be changed simply by pressing the corresponding numeric key. An error message will be displayed if the entered value is outside the allowed range. Other displays and internal settings remain unchanged when an error occurs.

Example: Changing the waveform type from the current  (sine wave) to  (square wave) or to  (triangular wave).

Key Operation	Display Result
Press FCTN .	Currently selected waveform (<SIN>1) will be displayed.
Press 3	Waveform changes to  >3 (square wave).
Press 2	Waveform changes to  >2 (triangle wave).

Parameters that require units, such as frequency, amplitude, and phase, can be changed by entering the new value with the numeric keys and pressing the appropriate **ENTER** key to complete the parameter entry process. While entering the new value, the current parameter value, unit display, and modification step size will disappear from the display, and the new value will be displayed.

To correct an entered value during the entry process, press the **RUB OUT** key, which will delete one character at the rightmost position of the entered number. To re-enter the entire parameter value from the beginning, press the same parameter key to return to the original parameter setting.

For frequency and amplitude, which have several units options, select and press the appropriate **ENTER** units key to complete the entry process. For phase, burst cycle, and duty cycle parameters, which have only single parameter units, press the applicable **ENTER** key to complete entry (deg, cycle, or %).

Regardless of the number of digits for the entered value and the size of the units (kHz, Hz; sec, msec; V, mV; or Vrms, mVrms), the predetermined number of digits, resolution, and units will all be properly adjusted and displayed. When values below the display resolution are entered with the numeric keys, the value will be rounded to the nearest whole number and set accordingly.

When inappropriate values are entered, an error message will be displayed, and the display will return to the previous value. Internal settings will remain unchanged when an error condition occurs.

Example: To change frequency from a current value of 1Hz to 2.54Hz. (Correcting an entered value of "2.55" during entry.)

Key Operation	Display
Press FREQ	Currently selected frequency "1.0000Hz" will be displayed.
Press 2	The value of the key pressed (2) will appear.
Press .	The decimal point appears to the right of the 2.
Press 5	The display now shows "2.5".
Press 5	The display indicates "2.55".
Press RUB OUT	The last 5 is deleted, and the display reads "2.5".
Press 4	The display indicates "2.54".
Press Hz	Entry is complete, and the display shows "2.5400Hz"

3.5.2 Setting Parameters using MODIFY

You can change parameter values with the MODIFY knob and cursor keys in the following situations:

- When the name of the parameter to be changed is blinking in the upper part of the liquid crystal display. (The parameter name indicated in the upper part of the liquid crystal display will not flash when the unit is in the GPIB remote mode, or when the keyboard lock is on.)
- If the current value specified is displayed, and the modification step size is presented in the upper right corner of the liquid crystal display. (Modification step size will not be displayed during numeric key input; modification cannot be performed during numeric input.)

For parameters that are selected with one numeric character (such as waveform and oscillation mode), the flashing cursor is fixed below the numeric character and cannot be moved. The step size is fixed to ± 1 and cannot be changed. For parameters that require units (such as frequency and amplitude), the step size can be changed by pressing the STEP SIZE key.

It is not necessary to use a units key when changing the value with the MODIFY knob. When modifying an existing value, the modified value will automatically replace the old parameter value, and the current units will remain unchanged.

When the step size is indicated in the rightmost position of the liquid crystal display, the step size will change in the following order each time the STEP SIZE key is pressed: ± 1 ± 5 $\times \div 2$ $\times \div 10$ ± 1 ...

When the step size is ± 1 or ± 5 , you can specify the digit for UP/DOWN adjustment by placing the flashing underline cursor under the appropriate digit with the cursor keys and turning the MODIFY knob to the right or left. When the step size is $\times \div 2$ or $\times \div 10$, the cursor will disappear, and you can multiply or divide by 2 or 10 by turning the MODIFY knob to the right or left. The step size and the current cursor position will be stored with the respective parameters when those parameters are stored in memory.

Changing a value by modification will never result in an error because the modification process automatically

limits parameter adjustments to the maximum allowed range for that particular parameter. MODIFY cannot be used to store or recall memory locations, or to set the GPIB address and delimiter; only the numeric keys can be used to program these operating modes.

3.5.3 Error Codes

When an error occurs, the Model 3930A displays an error code in the upper right corner of the liquid crystal display, and the unit generates a long beep sound (if the beep sound setting is on). The Model 3930A then displays the current specified parameter value.

Displayed error codes and their meanings are summarized below. The error number at the end of each code corresponds to the GPIB error code returned with the "?ERR" inquiry.

Er GPIB00

- The Model 3930A received a non-recognizable programming or inquiry command over the GPIB.

Examples:

"ABC 2": Non-recognizable programming command is given.

"?ABC": Non-recognizable inquiry command is given.

"123.4": Parameter values are given without headers.

- The Model 3930A received a command that is not recognized in the current mode.

Examples:

Frequency setting command is given during sweep operation.

- The Model 3930A received a command string that is beyond the capacity of the GPIB input buffer.

Er UNIT01

- You attempted to specify an incorrect parameter unit

Examples:

You pressed the dBV key while programming frequency

You pressed the *Vrms* key while setting the offset voltage.

- You attempted to select an unacceptable unit for other settings.

Example:

You attempted to specify an amplitude value other than p-p for a DC waveform type.

- When the output range mode is fixed, you attempted to set the amplitude using other than p-p units.

Er FREQ02



- You attempted to specify a frequency setting outside the range of 0.0001Hz to 1,200kHz.
- You attempted to specify a period setting outside the allowed range of 0.00084sec to 10,000sec.
- You attempted to specify a sweep start, stop, center, span, or marker frequency or period parameter outside the allowed range.
- You attempted to specify a value that causes the resulting start or stop frequency to exceed the allowed sweep center or span frequency (period) range.

Er PHAS03

- You attempted to specify a phase setting value greater than $\pm 360^\circ$.

Er AMPT04

- You attempted to specify an amplitude setting outside the range of 0.30mVp-p to 30.0Vp-p (AUTO output range mode) or 0.00Vp-p to 30.00Vp-p (FXD output range mode).
- When setting the amplitude using other than p-p units in the AUTO output range mode, you attempted to program a value outside the following range for the selected waveform:

 : 0.11mVrms to 10.6Vrms, -79.2dBV to 20.5dBV
 : 0.15Vrms to 15.0Vrms, -76.5dBV to 23.5dBV
 : 0.09mVrms to 8.66Vrms, -80.9dBV to 18.8dBV

Er OFST05

You attempted to specify a DC offset value greater than $\pm 15V$.

Er ACDC06

For an AC waveform with a non-zero DC offset, you attempted to specify an invalid amplitude or DC offset value.

The following restrictions apply when adding DC offset to the AC waveform:

- AC amplitude setting $(V_{p-p})/2 +$ DC offset voltage setting $[V_{p-p}] \leq 15V$
- When the output range mode is AUTO, the amplitude setting must be equal to or larger than the minimum AC amplitude determined by the sum of the voltages above. In addition, the DC offset must not be added to limit the above restrictions. See Appendix B and paragraph 3.5.7 for more details on these restrictions.

Er FRDT07

- You attempted to output square waves with variable duty cycle at a frequency greater than 100kHz.

Examples:

You attempted to change the square-wave duty cycle from 50% with a frequency greater than 100kHz and a  waveform.

You attempted to set the frequency above 100kHz with the unit set to output square waves with variable duty cycle.

Er SWP08

- You attempted to perform sweep operations with an invalid sweep range and sweep time.

Examples:

You attempted to perform a log sweep operation with the sweep set below one decade.

You attempted to begin a sweep operation with the sweep start frequency and the sweep stop frequency set to the same frequency.

You attempted to change the sweep time to 10msec during the execution of a two-decade log sweep.

You attempted to change the sweep time or sweep span to invalid values during sweep operation.

You attempted to set the sweep start frequency and sweep stop frequency to the same frequency during sweep operations.

Er RNGE09

You attempted to specify a value outside the predetermined range, resulting in a condition other than errors 02 through 08.

Examples:

You entered a value of 6 during waveform selection.
You attempted to set the sweep time to 3msec.

Er CONV10

The result of the units conversion is outside the allowed range of the given value. This occurs because of restrictions on the number of digits and display resolution and because of computational errors.

Examples:

You attempted to convert a 0.30mVp-p value of a sine wave to rms units. This error occurs because the internal algorithm converts 0.30mVp-p to 0.10mVrms, which is below the lower limit of 0.11mVrms.

You attempted to convert an internal trigger rate of 2,999.9sec into frequency units. This error occurs because the conversion result is 0.0003Hz, which is below the specified lower limit of 0.0004Hz.

Er MEMO11

- An error was found in the backup memory at power-on for one or more parameter settings. If this error occurs, preset settings will be placed into effect.
- An error was found in the contents of the memory while recalling parameters. Parameter settings will not be changed, and the Model 3930A will return to the prompt for the memory number to recall.

3.5.4 Units Conversion

The Model 3930A can display frequency, rate and amplitude in different units. Frequency or rate can be displayed as *period* or *frequency*, while amplitude can be

displayed in p-p, rms, or dBV units (except in the fixed output range mode, in which case only p-p units can be used). You can convert from one type of units to another by pressing the appropriate units key when the Model 3930A is in the appropriate parameter-setting mode.

Example:

Assume that the Model 3930A is in the frequency-setting mode and displays a current frequency of 1.000 000 0kHz. Pressing sec or ms converts from frequency to period units, and the unit displays 1.00000msec.

Note that internal settings remain unchanged when the units conversion is performed. The Model 3930A automatically displays the result of units conversion as the current specified value, and you can modify the value using the converted units, if desired.

Frequency Units Conversion

Frequency to period: Press the sec or ms key when the Model 3930A is displaying frequency.

Period to frequency: Press the kHz or Hz key when the Model 3930A is displaying period.

The actual, specified value is always displayed for the frequency, and the frequency accuracy specifications stated in Appendix B apply. However, the period displayed is the result obtained by rounding off the reciprocal of a given frequency to the predetermined number of digits according to the selected resolution (the reciprocal is truncated for values lower than the resolution), and the result is displayed. Note, therefore, that the period displayed as the result of units conversion contains a larger error when the programmed frequency is high.

Example:

Assume that frequency of 1150.000 000 0kHz (actual period of 0.00086956msec) is converted to period display. The value is rounded and displayed as 0.00086msec. The result is an error equivalent to -1.1% of the correct period.

Internal Trigger Rate Units Conversion

Period to frequency: Press the Hz or kHz key when the unit is displaying period.

Frequency to period: Press the sec or ms key when the Model 3930A is displaying frequency.

The actual, specified value is always displayed for the internal rate period, and the period accuracy specifications stated in Appendix B apply. However, the frequency displayed is the result obtained by rounding off the reciprocal of a given period to the predetermined number of digits according to the selected resolution (the reciprocal is truncated for values lower than the resolution), and the result is displayed. Note, therefore, that the frequency displayed as the result of units conversion contains a larger error when the programmed period is high.

Example:

A rate period of 2,350.0sec is converted to a frequency of 0.0004Hz, an error of -6% when compared to the correctly converted frequency.

Amplitude Units Conversion

p-p or rms to dBV: Press the dBV key when the Model 3930A displays the p-p or rms value.

p-p or dBV to rms: Press the Vrms or mVrms key when the Model 3930A displays the p-p or dBV value.

rms or dBV to p-p: Press the V or mVrms key when the Model 3930A displays the rms or dBV value.

NOTE

Amplitude units conversion is possible only in the AUTO output range mode. Only p-p units can be specified in the FXD (fixed) output range mode. See paragraph 3.5.12 for details on the output range mode.

For amplitude, no one-to-one correspondence for actually specified values exists. Because a given value is rounded off according to restrictions on the number of display digits and the resolution for each type of units, the amplitude display may not return to exactly the same value after conversion from one type of units to another and back to the original units.

3.5.5 Frequency Programming

Pressing the **FREQ** key displays the current frequency and enables frequency programming. (During a sweep or sweep hold, however, the frequency cannot be programmed, but the current frequency can still be displayed by pressing **FREQ**.)

To program the frequency using the numeric keys, press the **kHz**, or **Hz** key after entering the value. The resolution of a frequency value is 0.1mHz. When the specified frequency is below 1kHz, the value will be displayed in Hz units. For 1kHz and above, the frequency will be displayed in kHz units. To specify the frequency in period units instead of frequency units, press one of the time period keys (sec or ms). Frequency programming for sweep operations is identical.

The allowed frequency range for sine and square waves (with fixed 50% duty cycle) is from 0.0001Hz to 1,200kHz; for other waveforms, the upper limit is 100kHz for good quality waveforms. The absolute upper limit for variable duty cycle square waves is 100kHz, but the frequency can be set as high as 1,200kHz for \surd , \swarrow , and \searrow waveforms of reduced quality.

The unit accepts a maximum of six digits and has a resolution of 10nsec for the frequency parameter. The actual oscillation frequency is obtained by truncating the reciprocal of the given value to an acceptable number of digits on the part of the value smaller than 0.1mHz.

When frequency programming is enabled, you can change the present value with the **MODIFY** knob. The knob can be used to change the value during both frequency display and period display. When the step size is ± 1 or ± 5 , you can select the digit to change by placing flashing underline cursor under the appropriate digit and turning the **MODIFY** knob to the right or left. When the step size is $\times \div 2$ or $\times \div 10$, the cursor will disappear, and you can divide or multiple the value by 2 or by 10 by turning the knob to the left or right.

Note that when the displayed period is obtained from a frequency specified with an insufficient number of digits, the actual oscillation frequency may not be changed even if the value is changed with the numeric keys or the **MODIFY** knob. The Model 3930A always displays a correct value for frequency.

3.5.6 Output Amplitude and Amplitude Modulation

Output Amplitude

Pressing AMPTD displays the present amplitude and enables amplitude programming. When using numeric keys to set the amplitude, press the appropriate units key to complete the entry process (only p-p units can be specified in the fixed output range mode). Press V or mV to enter p-p units, use Vrms or mVrms for rms units, or press dBV for dBV units. MODIFY can also be used to change an existing amplitude value.

When the DC offset is 0V, the allowed amplitude range is 0.30mVp-p to 30.0Vp-p (AUTO output range mode) or 0.00Vp-p to 30.00Vp-p (FXD range mode). If, however, the programmed DC offset is not 0V, certain restrictions concerning the maximum allowable amplitude apply, and certain combinations of amplitude and offset values may result in the "Er ACDC06 error". Paragraph 3.5.7 describes these restrictions in more detail.

In the AUTO output range mode, the amplitude can be programmed in rms or dBV units. The rms and dBV values are set on the assumption that the average or center level of the peak-to-peak amplitude of the waveform is 0V. Thus, these values do not depend on the DC offset value or square-wave duty cycle.

The AMPTD key sets the amplitude for AC waveforms only; use the OFFSET key to set the DC output voltage of the DC waveform type. When the DC waveform is selected, you still can program the amplitude, but that value can be entered only in p-p units (the allowed amplitude ranges from 0.30mV p-p to 30.0V p-p, AUTO output range mode; 0.00V to 30Vp-p, FXD output range mode). The specified value is stored, and it is used as the given amplitude for the next selected AC waveform.

Amplitude Modulation (AM)

Pressing the AM key allows you to turn amplitude modulation on or off (1=ON, 0=OFF). You can use the amplitude modulation function for all waveforms except DC; however, amplitude modulation is intended primarily for use with sine waves up to 100kHz in frequency.

When AM is on, the selected AC output waveform is amplitude modulated by an external signal applied to the AM IN BNC jack. If the voltage of this modulating signal is V_m (in volts), the amplitude of the modulated output waveform is expressed as follows:

$$\text{Output amplitude(p-p/rms)} = 0.5 \times [\text{Displayed amplitude(p-p/rms)}] \times (1 + V_m)$$

The range of V_m is $-3V$ to $+1V$. When $V_m = 0V$, the output waveform is unmodulated, but the actual waveform output amplitude is one-half the displayed amplitude. When $V_m < -1V$, the output phase is inverted.

100% modulation occurs when $V_m = \pm 1V$ (2V p-p). If a DC offset of $-1V$ is added to V_m , the carrier is suppressed. If a DC offset of $-2V$ is added to V_m , modulation occurs with the phase of the output waveform inverted.

3.5.7 DC Offset Programming

Pressing the OFFSET key displays the current DC offset value and enables offset voltage programming.

When using the numeric keys to set the offset, press the V or mV key after entering the value to complete the entry process. As with other parameters, you can also use MODIFY to change an existing offset value.

With a DC waveform, the programmed offset voltage is the DC voltage value that appears at the output jack. Valid offset values are within the range of $+15V$ to $-15V$.

For all AC waveforms, the DC offset is added to the average value of the peak-to-peak amplitude of the AC waveform. Certain restrictions apply for amplitude-offset combinations, and some combinations of values may cause an error (Er ACDC06) to occur. Even values that are valid in a final combination may cause errors when setting up that combination. See Table B-3 (Appendix B) and Figure 3-8 for relational range restrictions. To prevent errors from occurring while programming amplitude-offset combinations, first set the offset to 0V, change the amplitude, then set the offset to the desired value. Use Figure 3-8 as a guide when programming offset and amplitude.

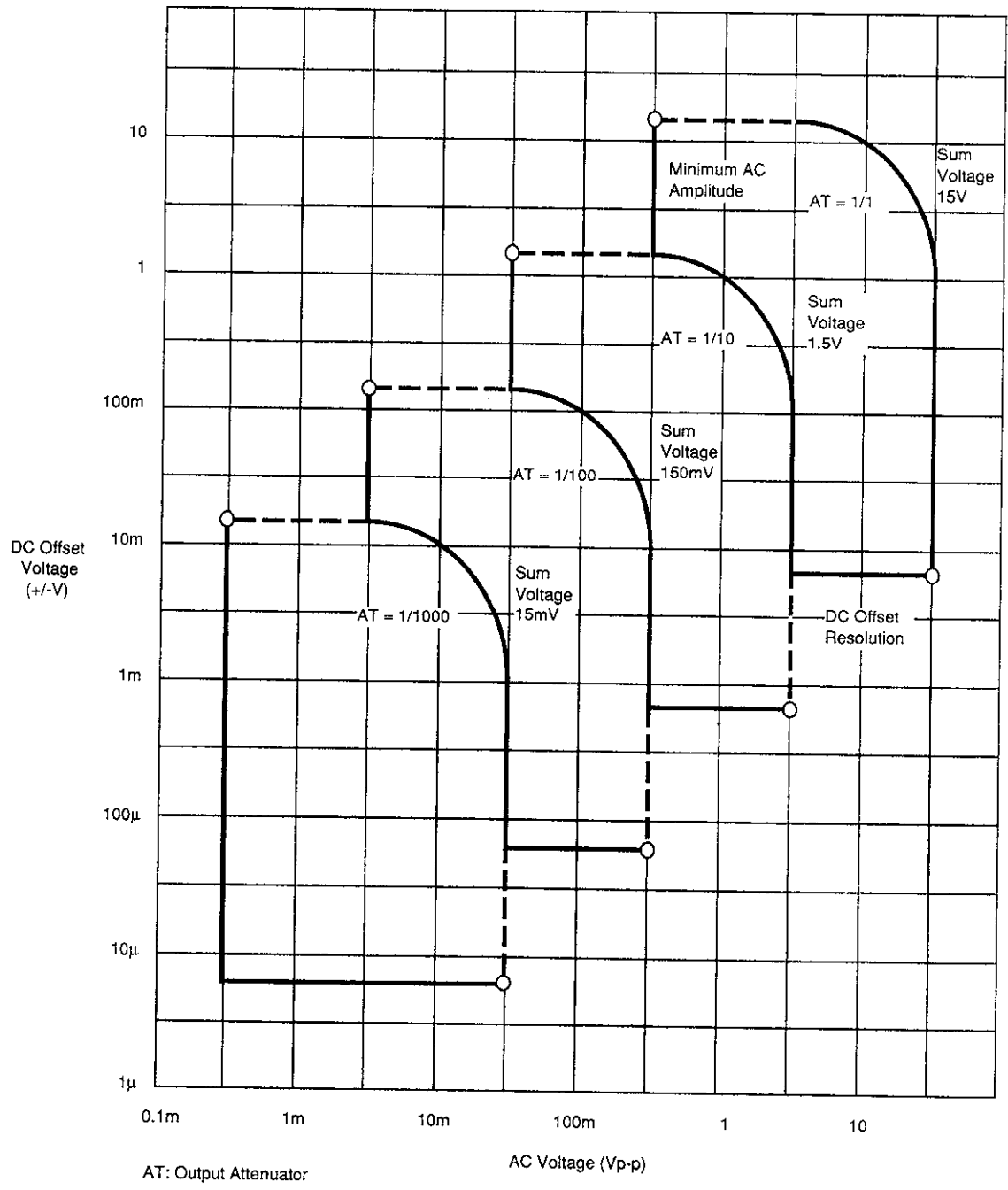

Figure 3-8. Relational Range for Allowed AC Amplitude Voltage and DC

Examples:

An error occurs if you attempt to set the DC offset to 10V when the amplitude is set to 12Vp-p. This error occurs because the sum voltage is $12/2 + 10 = 16V$, which is greater than the maximum 15V output voltage.





When the unit is set to the AUTO output range mode, an error occurs if you attempt to set the amplitude to 100mVp-p when the DC offset is 5V. This error occurs because the specified amplitude is less than the minimum AC amplitude of 286mVp-p for sum voltages greater than or equal to 1.5V.

Again, assume that the output range mode is AUTO, the current amplitude is 100mVp-p, the offset is 1V, and that you want to use a 500mVp-p amplitude and a 5V DC offset in combination with one another. An error occurs if you attempt to set the offset to 5V before changing the amplitude (the error occurs because the current 100mV amplitude is less than the minimum 286mVp-p for sum voltages greater than or equal to 1.5V). To avoid an error in this situation, first set the amplitude to 500mVp-p, and then set the DC offset to 5V.

Although the hardware determines the ultimate resolution, the Model 3930A displays the amplitude and DC offset to the predetermined number of digits and resolution. As a result, programming amplitude or offset values below the resolution of the hardware will result in display changes only; the actual output will not change. These resolution limits apply to AC only, DC only, and AC + DC output waveforms. In particular, if the AC + DC voltage ratio is large, the accuracy of small setting values is decreased. See Table B-1 and Table B-3 (Appendix B) for details on these limitations.

3.5.8 Waveform Selection, Square-Wave Duty Cycle, and Synchronous Output

Waveform Selection

Pressing the FCTN key displays the current waveform function along with its corresponding number and enables waveform selection. Available waveforms include: DC, SIN, , , , and .

To select a waveform with the numeric keys, simply press the numeric key that corresponds to the desired waveform. For example, press 1 to select a sine wave. The waveform will change immediately when the corre-

sponding key is pressed; it is not necessary to press a units key.

When the Model 3930A displays the current waveform, and function parameter selection is enabled, you can change the waveform by turning the MODIFY knob. Turning the knob clockwise increases waveform numbers, while turning the knob counter-clockwise decreases waveform numbers (one number increment per knob detent). When the highest or lowest waveform numbers are reached, the number will wrap around to the lowest or highest selection (function numbers range from 0 through 5).

For all AC waveforms, the p-p value of the amplitude will remain unchanged when you change the waveform. If the amplitude is specified in units other than a p-p value (AUTO output range mode only), the amplitude will be converted to p-p units when the waveform is changed.

Finally, the waveform output is momentarily turned off when the waveform function is changed.

Square-Wave Duty Cycle

The duty cycle is the ratio of the time period of the waveform high-level duration to the time period of one complete cycle of the waveform expressed as a percentage. For example, assume a 10kHz square wave has a time period of 100μsec. If the high portion of the waveform has a period of 30μsec, the duty cycle is $30/100 \times 100 = 30\%$.

Two square-waveform duty-cycle modes are available: one with the duty cycle fixed at 50% and the second mode with a variable duty cycle. The duty cycle applies only to the square-wave function (waveform 3), although the duty cycle can be programmed while other waveforms are selected. When the Model 3930A is in the variable duty-cycle mode, the upper-frequency limit is 100kHz, and the maximum jitter is 150nsec or less.

To change the duty cycle, press the  DUTY key, and enter or modify the duty cycle (5.0% to 95.0%). The Model 3930A stays in the variable duty cycle mode even if you set the duty cycle to 50%. To select the fixed 50% duty cycle mode, press SHIFT FXD50. In the duty cycle display mode, the Model 3930A displays "fixed" for the 50% fixed mode or "var" for the variable duty-cycle mode.

Note that the duty cycle setting also changes the duty cycle of the SYNC OUT signal.

To extend the duty cycle range, use the burst oscillation mode and one square waveform cycle. Refer to paragraph 3.5.9 for details on setting the oscillation mode.

Synchronous Output

Figure 3-9 illustrates the phase relationship between the waveform and synchronous output (SYNC OUT) at frequencies below 1kHz. Note that at high frequencies, internal circuit delays result in a substantial phase differential between the waveform output and synchronous output signals.

3.5.9 Oscillation Mode

Oscillation Mode Selection

Pressing the MODE key displays the current oscillation mode along with its corresponding number and enables oscillation mode selection. Available oscillation modes include continuous, burst, and gate modes.

To select the oscillation mode with the numeric keys, simply press the numeric key that corresponds to the desired oscillation mode. For example press 1 to select the burst mode. Pressing the numeric key will change the setting immediately; it is not necessary to press a units key when setting the oscillation mode.

When the Model 3930A displays the current oscillation mode, and mode selection is enabled, you can also change the mode by turning the MODIFY knob. Turning the knob clockwise increases the oscillation mode number, while turning the knob counter-clockwise decreases the oscillation mode number (one digit per detent setting). When the highest or lowest mode number is reached, the number will wrap around to the lowest or highest value (mode values range between 0 and 2). Note that the cursor position is fixed, and the step size is fixed at ± 1 .

Continuous Mode

When the continuous mode is selected, the instrument generates the selected waveform continuously. Triggering is not required, and the selected burst cycle and internal rate parameters have no effect on the output waveform.

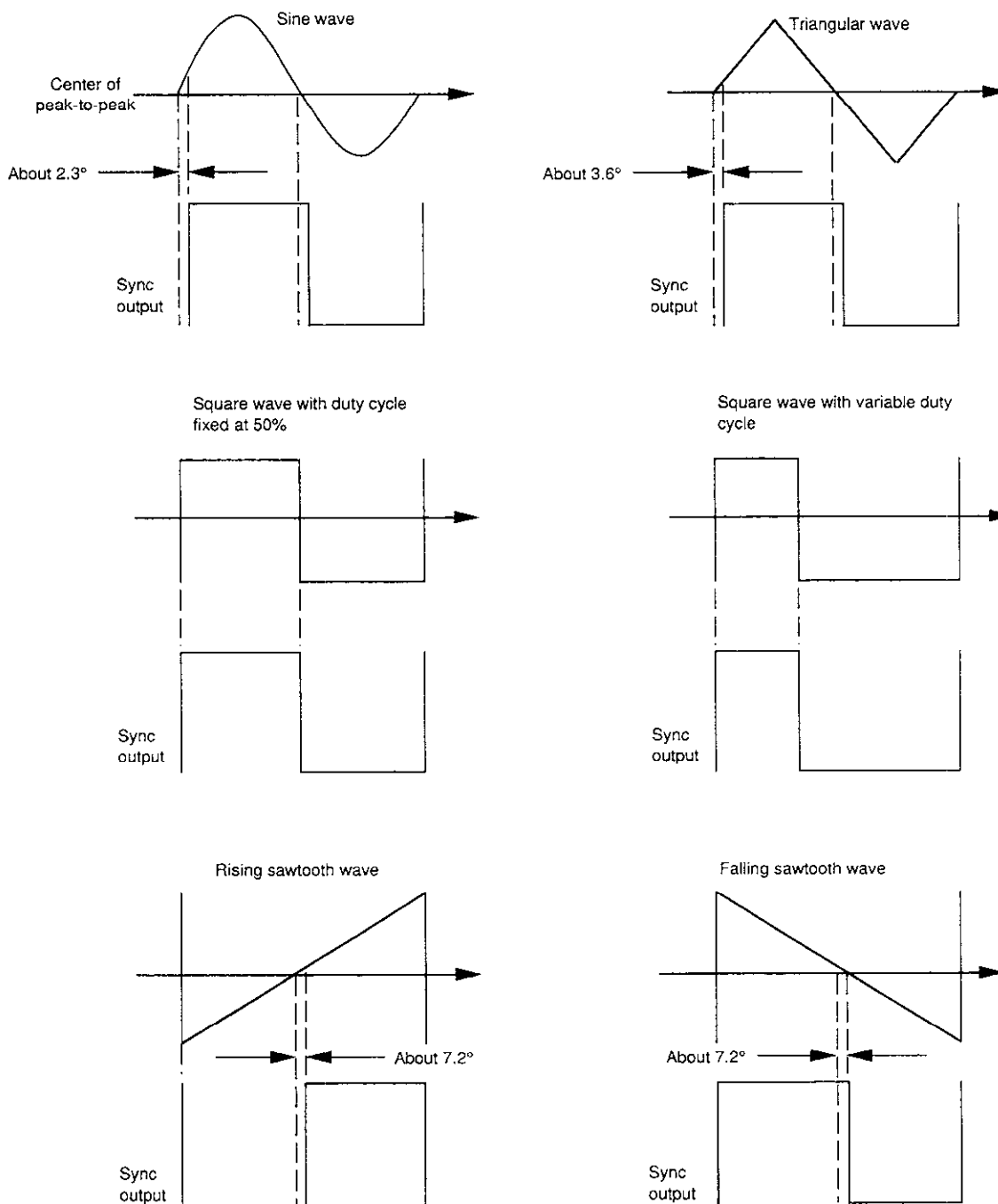

Figure 3-9. Phase Relationship between Waveform and Synchronous Output

Burst Mode

In the burst mode, the instrument generates the selected waveform for the number of programmed burst cycles (using the BURST CYCLE key) and then stops oscillation until it is retriggered, either internally or externally, depending on the selected trigger source. During the burst mode, further triggers are ignored and will not retrigger the unit.

If the internal trigger source is selected (either INT ∇ or INT \blacktriangle), the on-off burst repetition rate is determined by the programmed internal rate parameter, which is programmed with the INT RATE key. If the external trigger source is selected, one burst per trigger is generated. The external source is either a signal applied to the EXT TRIG IN jack or the MAN key (the EXT TRIG IN signal can be used with both EXT ∇ and EXT \blacktriangle trigger sources, but the MAN key is operational only for the EXT ∇ source with EXT TRIG IN high, or with EXT \blacktriangle and EXT TRIG IN low).

Figure 3-10 shows an example of the burst oscillation mode. In this example, the unit is set for three burst cycles.

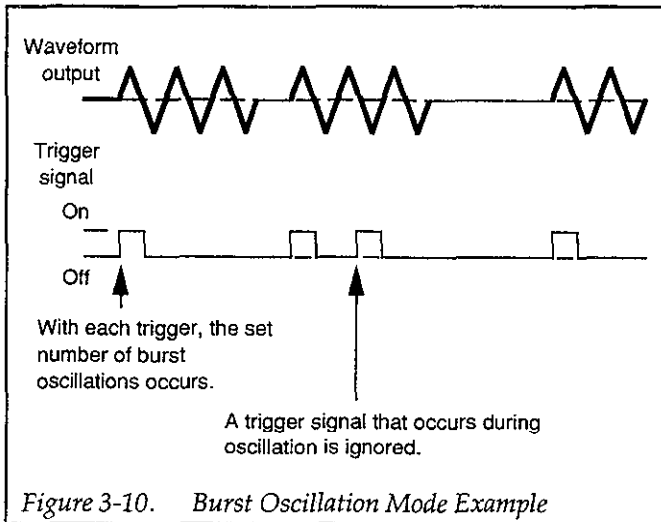

Gate Mode

In the gate mode, the unit generates oscillations as long as the gate signal (trigger signal) is on. When the gate signal turns off, the Model 3930A will always stop oscillating at the end of one complete cycle even if the gate signal turns

off at the mid point of a cycle. Thus, the Model 3930A always provides integral cycles of oscillation.

With internal trigger source selected, gating is performed by the internal trigger signal. With an external trigger source, gating is performed either by a signal applied to EXT TRIG IN, or by pressing the MAN key.

Figure 3-11 demonstrates the gate oscillation cycle for a variable-duty cycle square wave. Conditions for this example are: waveform: square, duty cycle: fixed 50%, burst cycles: 1, start/stop phase: -90° .

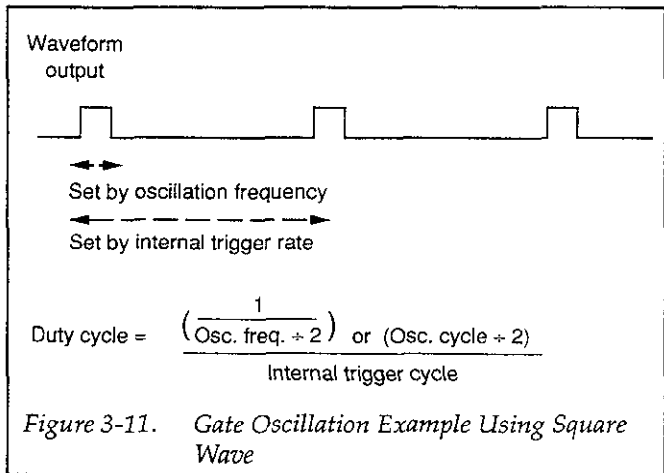
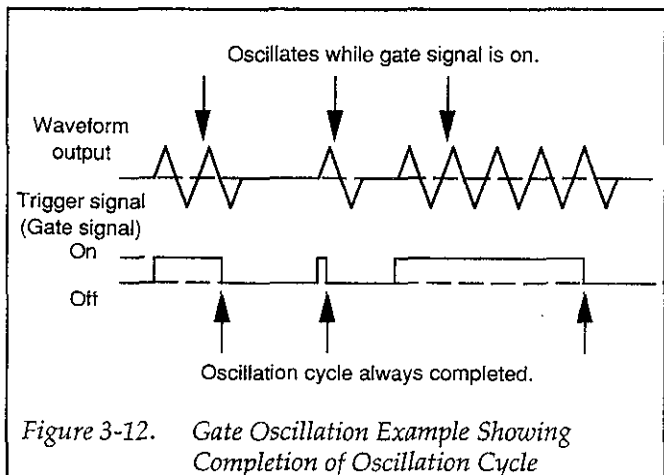

Figure 3-12 demonstrates how the output waveform always completes the current cycle when the gate signal turns off.



NOTES:

1. In the burst or gate oscillation modes, if the next trigger is applied at about the same time the unit terminates oscillation, oscillation may become unstable. In this situation, temporarily change the oscillation mode, then return the unit to the original mode. Oscillation will then return to normal.
2. If the external, leading-edge trigger source is selected with the unit in the gate oscillation mode, the gate signal is effectively on, and the unit performs continuous oscillation if the front panel EXT TRIG IN connector is left disconnected from an external trigger signal. This condition occurs because EXT TRIG IN is internally pulled up to a high logic level, and the circuit logic level is equivalent to applying a high input signal when EXT TRIG IN is left disconnected.
3. You can use the MAN key to manually trigger the unit in the gate or burst oscillation modes only under the following conditions
 - A. If the trigger source is set to EXT ∇ , and EXT TRIG IN is left disconnected or a high-level signal is applied to this connector.
 - B. If the trigger source is set to EXT \blacktriangle , and a low-level signal is applied to EXT TRIG IN.

3.5.10 Trigger Parameters (Source, Rate, Burst Cycle, and Phase)

Trigger Source

Pressing SOURCE displays the current trigger source with its corresponding number and enables trigger source selection. Available trigger sources include external (a trigger signal applied to the EXT TRIG IN jack), and internal (internal trigger rate generator). Rising-edge (\blacktriangle) and falling-edge (∇) signals can be selected for both external and internal trigger sources. Note that selecting internal trigger automatically selects the internal trigger generator as the trigger source.

In the gate oscillation mode with the trigger source set to external \blacktriangle , the gate signal will be on, and the Model 3930A will oscillate continuously when the EXT TRIG IN BNC connector is left disconnected. This situation is the result of the internal pull-up resistor connected to the external trigger input. Thus, leaving the external trigger input connector disconnected is equivalent to connecting a high logic level.

Internal Rate

The internal rate parameter sets the frequency of the internal trigger oscillator, which is used to trigger the unit in the burst and gate oscillation modes when an internal trigger source is selected. In the burst oscillation mode, the burst-repetition rate is determined by the internal rate setting. Similarly, the internal rate parameter sets the on-off gate frequency in the gate oscillation mode.

In order to program the internal rate parameter, press the INT RATE key. The unit will display the present rate, and you can then enter the value with numeric keys or change the rate with MODIFY, as desired. The allowable range for the rate parameter is from 0.001msec to 2,999.9sec.

You can also program the rate parameter in terms of frequency. To do so, simply press the kHz or Hz key to complete parameter entry. The allowed range is from 0.0004Hz to 1,000.0kHz. When setting the rate as a frequency, the reciprocal of the parameter is rounded off after truncating the portion below the resolution. As a result, errors become large when the frequency is high. For example, values of 1,000.0kHz and 600.00kHz will both result in a period of 0.001msec.

Burst Cycle

Press BURST CYCLE to program the burst cycle parameter, which sets the number of oscillation cycles the unit generates each time it is triggered in the burst oscillation mode. When the unit is in the burst-cycle entry mode, you can program the value using the numeric keys or change that value with the MODIFY knob (use the cycle key to complete entry in the numeric entry mode). The allowable range for the burst cycle parameter is from 1 cycle to 65,536 cycles.

Start/Stop Phase

Pressing the PHASE key displays the current start/stop phase and allows setting of that phase parameter, which controls the start/stop phase for the burst and gate oscillation modes. The allowed range for the start/stop phase parameter is from -360.0° to 360.0° with 0.1° resolution.

Phase definitions for the available waveforms are illustrated in Figure 3-13.

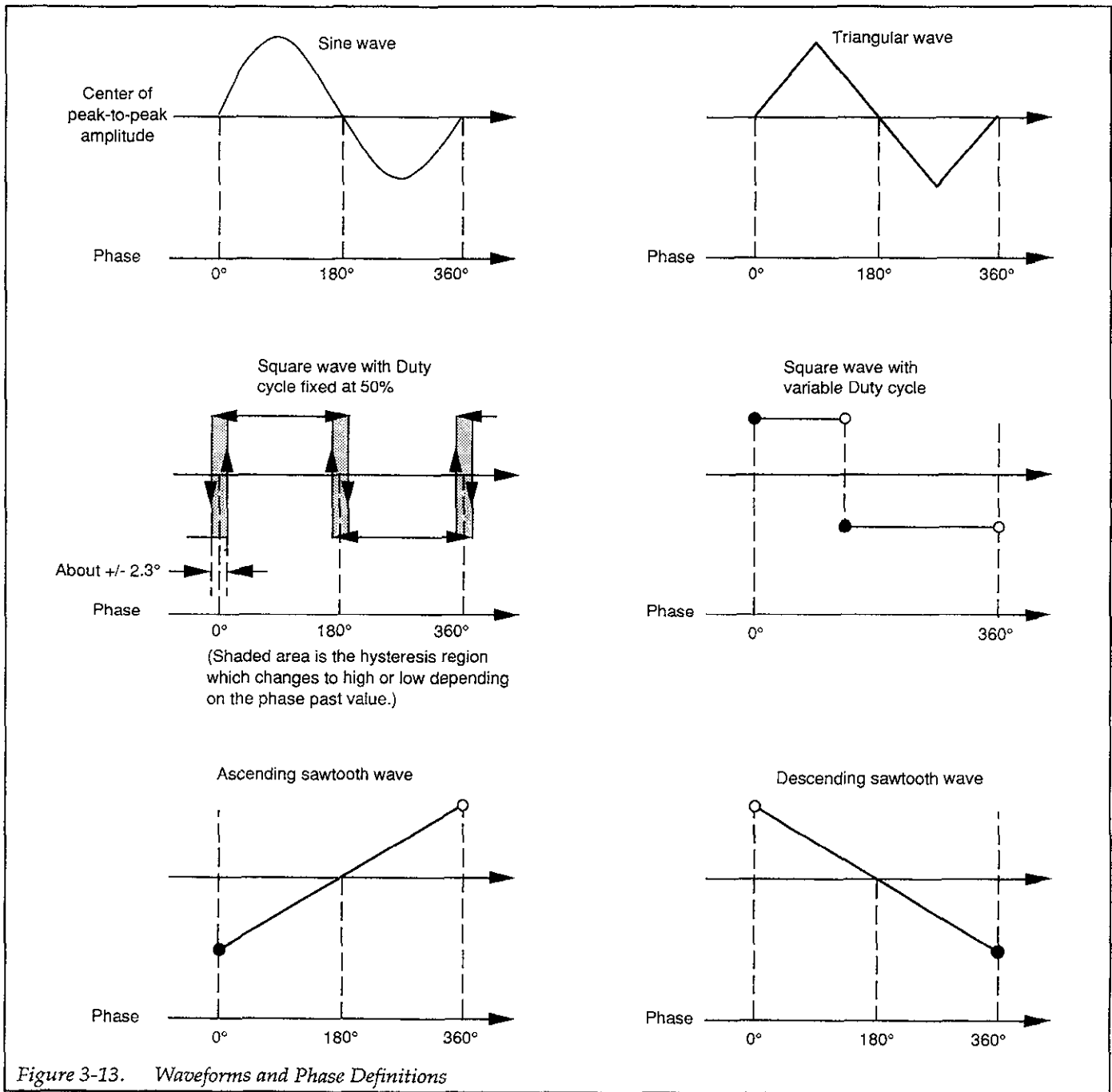

Figure 3-13. Waveforms and Phase Definitions

The Model 3930A generates square waves with a fixed 50% duty cycle by processing sine waves with a zero-crossing comparator that has hysteresis. The level of the generated square wave, therefore, alternates high and low at approximately 0° , $\pm 180^\circ$, and $\pm 360^\circ$ (within about $\pm 2.3^\circ$) depending on the past value of the phase. Thus, to set the square-wave start/stop level high, set the phase to 90° . Similarly, the phase should be set to -90° to set the square-wave start/stop level low.

The Model 3930A also generates the synchronous output for the sine, triangle, and sawtooth waves by passing each waveform through a zero-crossing comparator that has hysteresis. As a result, the synchronous output level changes at the same points as the square wave when the phase is approximately 0° , $\pm 180^\circ$, or $\pm 360^\circ$ for the sine or triangle waves, or about $\pm 180^\circ$ with the sawtooth wave.

When the Model 3930A is connected to the optional Model 3933A Phase Shifter to form a multiphase oscillator, the Model 3930A start/stop phase setting is also the phase offset. Refer to the Model 3933A Instruction Manual for multiphase oscillation phase setting information.

3.5.11 Frequency Sweep Operation

The Model 3930A can be set up to generate frequency sweeps over a variety of ranges. The following paragraphs discuss the various aspects of programming frequency sweeps. Figure 3-14 shows sweep waveforms.

Setting the Sweep Range

You can set the sweep range in one of two ways: (1) by setting the start and stop frequencies, or (2) by setting the center and span frequencies. The actual sweep is generated from the start frequency to the stop frequency, and the sweep direction is determined by the relative values of the start and stop frequencies. If the start frequency is lower than the stop frequency, an ascending-frequency sweep will be generated. If the start frequency is higher than the stop frequency, a descending-frequency sweep will be generated.

If you specify the center and span frequencies to set the sweep range, the Model 3930A will automatically convert them into start and stop frequencies. See the specifications in Appendix B for more details on the sweep range and sweep width.

The Model 3930A determines the sweep range as described below when you change a frequency parameter:

- When the start frequency is changed:

The stop frequency remains unchanged.

Center frequency =
(start frequency + stop frequency) / 2
(Portion of value below 0.1mHz is truncated.)

Span frequency = start frequency – stop frequency

- When the stop frequency is changed:

The start frequency remains unchanged.

Center frequency =
(start frequency + stop frequency) / 2
(Portion of value below 0.1mHz is truncated.)

Span frequency = start frequency – stop frequency

- When the center frequency is changed:

The span frequency remains unchanged.

The relationship between the start and stop frequency value remains the same as it was before the center frequency was changed:

Start frequency =
(center frequency \mp span frequency / 2)
(Portion of value below 0.1mHz is truncated.)

Stop frequency =
(center frequency \pm span frequency / 2)
(Portion of value below 0.1mHz is truncated.)

- When the span frequency is changed:

The center frequency remains unchanged.

The relationship between the start and stop frequency values remains the same as it was before the span frequency was changed:

Start frequency =
(center frequency \mp span frequency / 2)
(Part smaller than 0.1mHz is truncated.)

Stop frequency =
(center frequency \pm span frequency / 2)
(Part smaller than 0.1mHz is truncated.)

The start and stop frequencies always correspond to the opposite ends of the actual sweep range. When the span frequency is an odd number of 0.1mHz units, the displayed center frequency will be 0.05mHz higher than the

actual center frequency value. The center frequency is the center frequency on the linear scale, and it is not the center frequency based on the sweep time in the log sweep mode.

Sweep Function

Three sweep functions are available: \wedge (ascending, descending), \nearrow (ascending), and \sqcap (step). The \wedge sweep is generated by sweeping from the start frequency to the stop frequency and then sweeping back to the start frequency. The \nearrow sweep is generated by sweeping from the start frequency to the stop frequency and then returning to the start frequency instantly. The \sqcap sweep alternates between the start frequency and the stop frequency.

Sweep Time

Sweep time will vary depending on the selected sweep function.

- When the sweep function is \wedge :
Sweep time = time of transition from start frequency to stop frequency
= time of transition from stop frequency to start frequency
= half of repetition period of continuous sweep
- When the sweep function is \nearrow :
Sweep time = time of transition from start frequency to stop frequency
= repetition period of continuous sweep
- When the sweep function is \sqcap :
Sweep time = duration of start frequency in continuous sweep
= duration of stop frequency in continuous sweep
= half of repetition period of continuous sweep

When the sweep times for the \nearrow and \wedge sweep functions are identical, the sweep rate along the equivalent sloped

portions of the two waveforms will also be identical. Note, however, that the continuous-sweep repetition period for the two functions is different. See Figure 3-14 for more details on sweep progression.

Sweep Operations

Model 3930A sweep operations include the following eight types of sweeps:

Starting a continuous sweep (CONT START key).

Starting a single sweep (SINGL START key).

Holding and resuming a sweep (HOLD/RESM key).

Turning a sweep off to enable normal frequency programming (SWEEP OFF key).

Setting the output waveform to the start frequency (START STATE key).

Setting the output waveform to the stop frequency (STOP STATE key).

Starting a single sweep with external signals (SINGL START IN BNC jack).

Holding and resuming a sweep with external signals. (HOLD IN BNC jack).

Starting a Continuous Sweep

To start a continuous sweep, press SHIFT CONT START. During the sweep, the Model 3930A displays the sweep frequency, and the following message is displayed: "CONT SWEEP EXEC (EXIT:SWP OFF)". When the Model 3930A is in this mode, you cannot set the frequency with the FREQ key.

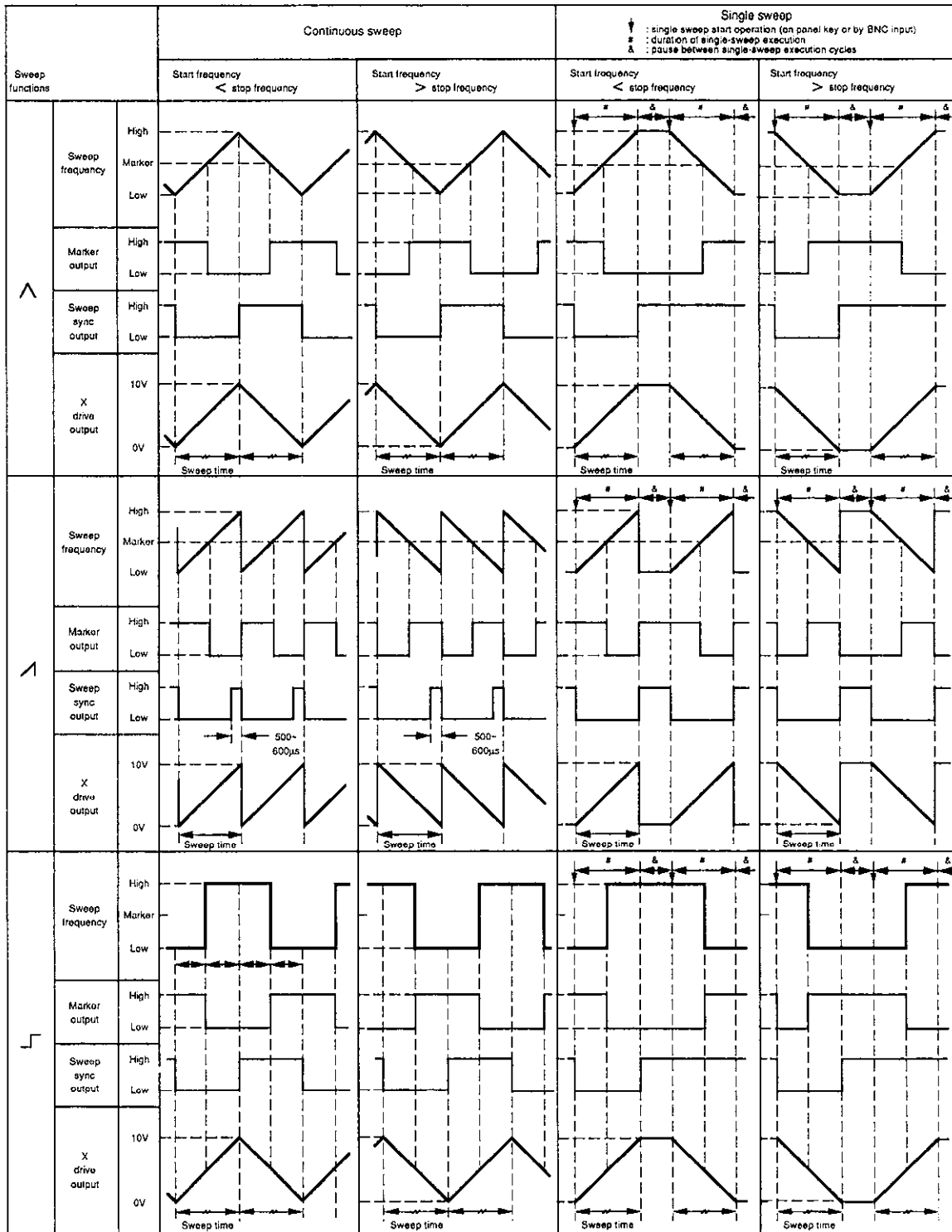

NOTE: The x-axis is the time axis, indicating increasing time toward the right.

Figure 3-14. Relationship Between Sweep Frequency and Sweep Output

Starting a Single Sweep

Press the **SINGL START** key to initiate a single sweep. During a single sweep, the Model 3930A displays the sweep frequency, and the following message is displayed: "SINGL SWEEP EXEC (EXIT:SWP OFF)". You cannot set the frequency with the **FREQ** key while the unit is generating a single sweep.

When the Model 3930A terminates a single sweep, it displays the terminated sweep frequency along with the following message "SINGL SWEEP END". Once the sweep has terminated, you can program the output frequency with the **FREQ** key. The **MKR OUT** and **SWEEP SYNC OUT** signals go high, and the **X DRIVE OUT** signal is set to 0V at the end of the sweep.

Holding/Resuming a Sweep from the Front Panel

To temporarily halt execution of a continuous or single sweep, press the **HOLD/RESM** key. The Model 3930A stops the sweep operation immediately, and it displays the frequency at which it stopped the sweep. The **MKR OUT**, **SWEEP SYNC OUT**, and **X DRIVE OUT** signals maintain their current values when the sweep is halted.

When a continuous sweep is paused, the Model 3930A displays "CONT SWEEP HOLD (EXIT:SWP OFF)"; similarly the unit displays "SINGL SWEEP HOLD (EXIT:SWP OFF)" when a single sweep is paused. When the Model 3930A is in the sweep hold mode, you cannot program the frequency with the **FREQ** key.

To resume a sweep starting at the frequency at which you stopped sweep operation, press the **HOLD/RESM** key again.

Turning a Sweep Off to Enable Normal Frequency Programming.

Press the **SWEEP OFF** key during a sweep or sweep hold to turn off a sweep and enable normal **FREQ** key programming. The **MKR OUT** and **SWEEP SYNC OUT** signals will be set high, and the **X DRIVE OUT** signal will be set to 0V.

When the **SWEEP OFF** or **FREQ** keys are pressed at the completion of a single sweep, during start frequency output, or during stop frequency output, normal frequency

programming will be enabled. In addition, the **MKR OUT** and **SWEEP SYNC OUT** signals will be set high, and the **X DRIVE OUT** signal will be set to 0V.

Setting the Output to the Start Frequency

Press the **START STATE** key to set the output waveform to the programmed start frequency. In this mode, the Model 3930A displays the start frequency along with the following message: "SWEEP STRT STATE". The **MKR OUT** and **SWEEP SYNC OUT** signals also go high during the start frequency mode. The **X DRIVE OUT** signal is set to 0V if the start frequency is lower than the stop frequency; it is set to 10V if the start frequency is higher than the stop frequency.

When the Model 3930A is in this mode, pressing the **FREQ** key enables normal frequency programming with the **FREQ** key and sets the **X DRIVE OUT** signal to 0V.

Setting the Output to the Stop Frequency

Press **SHIFT STOP STATE** to set the output waveform to the programmed stop frequency. While in this mode, the Model 3930A displays the stop frequency along with the following message: "SWEEP STOP STATE". During the sweep stop state, the **MKR OUT** and **SWEEP SYNC OUT** signals are set high. **X DRIVE OUT** is set to 10V if the start frequency is lower than the stop frequency; it is set to 0V if the start frequency is higher than the stop frequency.

When the Model 3930A is in this mode, pressing the **FREQ** key enables normal frequency programming with the **FREQ** key and sets the **X DRIVE OUT** signal to 0V.

Starting a Single Sweep Using an External Signal

A TTL-level, falling-edge signal, applied to the **SINGL START IN** BNC connector, starts a single sweep. This signal performs essentially the same operation as pressing the **SINGL START** key.

SINGL START IN is internally pulled up to a high logic level, and sweep operation is not affected when the this connector is left disconnected from external signals.

Holding/Resuming a Sweep with an External Signal

A TTL low-level signal, applied to the **SWEEP HOLD IN** BNC connector, places the Model 3930A in the sweep

hold mode. In the sweep execution mode, the Model 3930A halts the sweep as long as this input remains low. If you attempt to start a sweep when this input is low, the Model 3930A immediately enters the sweep hold mode. Note that pressing HOLD/RESM does not resume sweep operation with the hold signal held low; you must set SWEEP HOLD IN high to resume the sweep.

SWEEP HOLD IN is internally pulled up to a high logic level, and sweep operation is not affected when this connector is left disconnected from external signals.

Sweep Frequency and Sweep Output

Figure 3-14 illustrates how the sweep frequency and the MKR OUT, SWEEP SYNC OUT, and X DRIVE OUT signals change with time.

The MKR OUT signal is high when the sweep frequency is higher than the marker frequency. When the sweep function is \nearrow or \searrow , the high signal level is maintained even after a single sweep is terminated.

The SWEEP SYNC OUT signal goes low during the transition from the start frequency to the stop frequency. When the sweep function is \searrow , the frequency changes at the center point of this output signal.

The X DRIVE OUT jack supplies a voltage that varies between 0V and 10V in proportion to the lapse of sweep time, and according to the direction of the sweep frequency. The X DRIVE OUT signal also varies linearly with time in the log sweep or step sweep mode.

Substituting Marker Frequency for Center Frequency

Press SHIFT CTR \blacktriangleleft to set the center frequency to the current marker frequency value. This operation produces the same result as programming an identical frequency with the numeric keys. The marker frequency is not affected by this operation.

Changing Settings During Sweep Operation

Because of processing execution time in the sweep execution mode, the Model 3930A may respond to the keys and GPIB commands more slowly in the sweep mode than in other modes. If you change the sweep range, sweep time, or sweep function with MODIFY while the Model 3930A is in the sweep execution mode, the unit will recalculate the new parameters each time you change the setting, resulting in slower response.

If you set the sweep range based on center and span frequencies, an error may occur depending on the order of parameter selection whether or not the Model 3930A is in the sweep execution mode.

Example:

To change a 5kHz center frequency and an 8kHz span frequency to 2kHz and 3kHz respectively, you must first change the span frequency to 3kHz and then change the center frequency to 2kHz. If you first change the center frequency to 2kHz, an error will occur because this combination would result in a start frequency of -2kHz.

Number of Steps in a Sweep

Sweep operation of the Model 3930A is controlled by software. The software determines the number of steps in a sweep (excluding step sweep) so that the Model 3930A can perform as smooth a sweep as possible, considering the processing speed of the microprocessor and the resolution of the synthesizer (0.1mHz).

The number of steps in sweep can be roughly calculated as outlined below. The number of steps described here is the number of steps between the start frequency and the stop frequency when the sweep function is \wedge or \nearrow .

Linear Sweep Steps

In a linear sweep, the number of steps can be calculated as follows:

Number of steps: $[\text{Sweep width (Hz)} \times 10^4]$ or $[\text{Sweep time (sec)} \times 2000]$, whichever is greater.

If the single-step frequency increase/decrease width is equated to the step width, the step width can be represented as follows:

$$\text{Step Width (Hz)} = \frac{\text{Sweep width (Hz)}}{\text{Number of steps}}$$

The MKR OUT signal is synchronous with the sweep steps. With an ascending sweep, the MKR OUT signal is low when the sweep frequency is equal to or higher than the marker frequency. With a descending sweep, the marker output is high when the sweep frequency is lower than the marker frequency. The deviation between the set marker frequency value and the actual transition in the MKR OUT signal is:

$$\text{Marker Deviation (Maximum): } \pm \text{ Step width (Hz)}$$

The X DRIVE OUT signal will also change synchronously as the sweep progresses. Because of the 8-bit resolution, the maximum number of steps is 255. When the number of sweep steps is less than or equal to 255, the number of sweep steps and the number of X DRIVE OUT steps are the same.

Log Sweep Steps

The Model 3930A generates approximately logarithmic sweeps by overlaying linear sweeps of about 1/10 decade.

Number of steps per 1/10 decade:

$$\left[\frac{\text{Sweep time(sec)} \times 200 / \text{sweep width(decade)}}{\sqrt{\text{Lower limit frequency(Hz)} \times 50}} \right] \text{ or}$$

[whichever is smaller.]

Number of sweep steps:

$$\text{Number of steps per 1/10 decade} \times \text{sweep width(decade)} \times 10$$

Marker deviation: $\pm 25 / \text{number of steps per 1/10 decade}$ (%)

In either sweep mode, the frequency at which the marker output actually changes does not exceed the range between the specified start frequency and the stop fre-

quency. The value always increases or decreases monotonically.

3.5.12 Output Range Mode

Output Range Mode Description

Amplitude control for both AC waveforms and DC offset voltages is performed using both a multiplying D/A converter and an output attenuator. When the output range mode is set to AUTO, the output attenuator is controlled by the amplitude and DC offset values, and the output voltage is determined both by the multiplying D/A converter and the attenuator. Therefore, the waveform amplitude has 3-digit resolution (Vp-p and Vrms values) and 0.1dBV resolution (dBV values), and the DC offset also has 3-digit resolution. Since an output attenuator is used, waveform quality (waveform distortion, precision, and noise) remains high even when the output amplitude is low. Amplitude and DC offset are restricted to a range that does not exceed 15V cumulative voltage, but when the amplitude-to-offset voltage ratios become large, the voltage with the smaller value becomes less precise. Also, when the output attenuator switches, the waveform output is momentarily turned off, and the both the waveform and DC offset voltages are temporarily interrupted.

When the output range mode is set to FXD (fixed), the output attenuator is fixed at 0 dB, so that the output changes virtually instantaneously without interruption, even if frequency, amplitude, and DC offset are changed (note, however, the output signal is momentarily interrupted for waveform and AM on/off changes). Also, amplitude and DC offset can be independently set to values not limited by a 15V cumulative voltage value, and amplitude can be set to 0Vp-p. However, amplitude values can only be set in Vp-p units, and they cannot be converted to Vrms or dBV units. Also, only the A/D converter is used to set the amplitude, so the smaller the setting, the fewer the number of bits that are used for the value. As a result, and the output waveform quality is reduced. Also, although the amplitude can be set to 0 Vp-p, the actual output may differ somewhat from that value. This deviation from the ideal 0V value tends to increase as the output frequency increases.

Consequently, the AUTO output range mode is most effective in situations where it is important to have precise output settings and good waveform quality down to a low level, and in situations where output changes across a wide range with similar offset and amplitude levels are required. The FXD output range mode is most effective in

situations where the output (both waveform and DC offset) is relatively constant, or when a large DC offset is added to a waveform with a small amplitude. FXD is also a better choice in situations where output values are changed from 0 to full scale at equal increments.

The relation between setting resolution and number of digits when the output is AC only (when the DC offset is 0 volts), and when the output is DC only (when the waveform is DC) in AUTO/FXD output range modes is given in Figure 3-15. Figure 3-16 shows the setting resolution and number of digits for DC output values alone.

Output Range Mode Setting

Pressing SHIFT 0 displays the current output range mode setting and allows the mode to be set as desired. The two output range modes are: AUTO (0) and FXD (1). You can select the desired mode either by pressing the appropriate numeric key (0 or 1), or by rotating the MODIFY knob.

Note that the amplitude and DC offset setting ranges vary between the two modes, and that the amplitude and offset values for each output range mode are independently set and saved. Also, the waveform output is momentarily turned off when the output range mode is changed.

Memory Recall Operation

The output range mode and respective amplitude and DC offset values can also be stored in memory, but when settings are recalled from memory, operation differs depending on the present and recalled output range modes.

When the unit is presently in the AUTO mode, the output is temporarily turned off, settings stored in memory are recalled, and the output is turned on again after settings are recalled. However, if the unit is currently in the AUTO mode, and the recalled settings include the AUTO mode, the output waveform will be interrupted by the recall process only if the frequency changes during memory recall.

If the Model 3930A is currently in the FXD mode, and the recalled settings include the FXD mode, the output signal is not interrupted by memory recall except when a waveform or AM on/off change occurs, in which case the waveform output is momentarily turned off during the recall process.

When the output range mode changes as a result of memory recall (AUTO to FXD, or FXD to AUTO), the waveform output is always temporarily turned off regardless of other parameter settings.

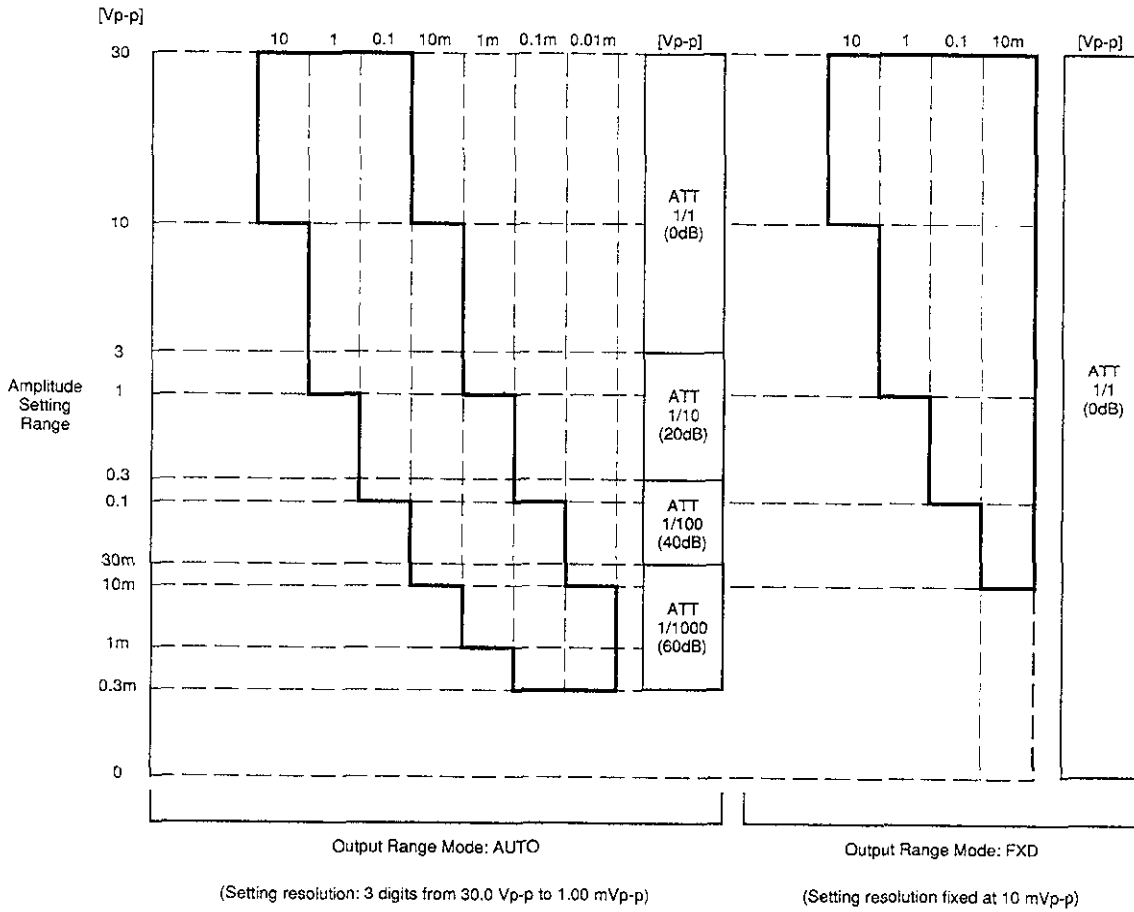

Figure 3-15. Output Resolution and Number of Digits for AC Only

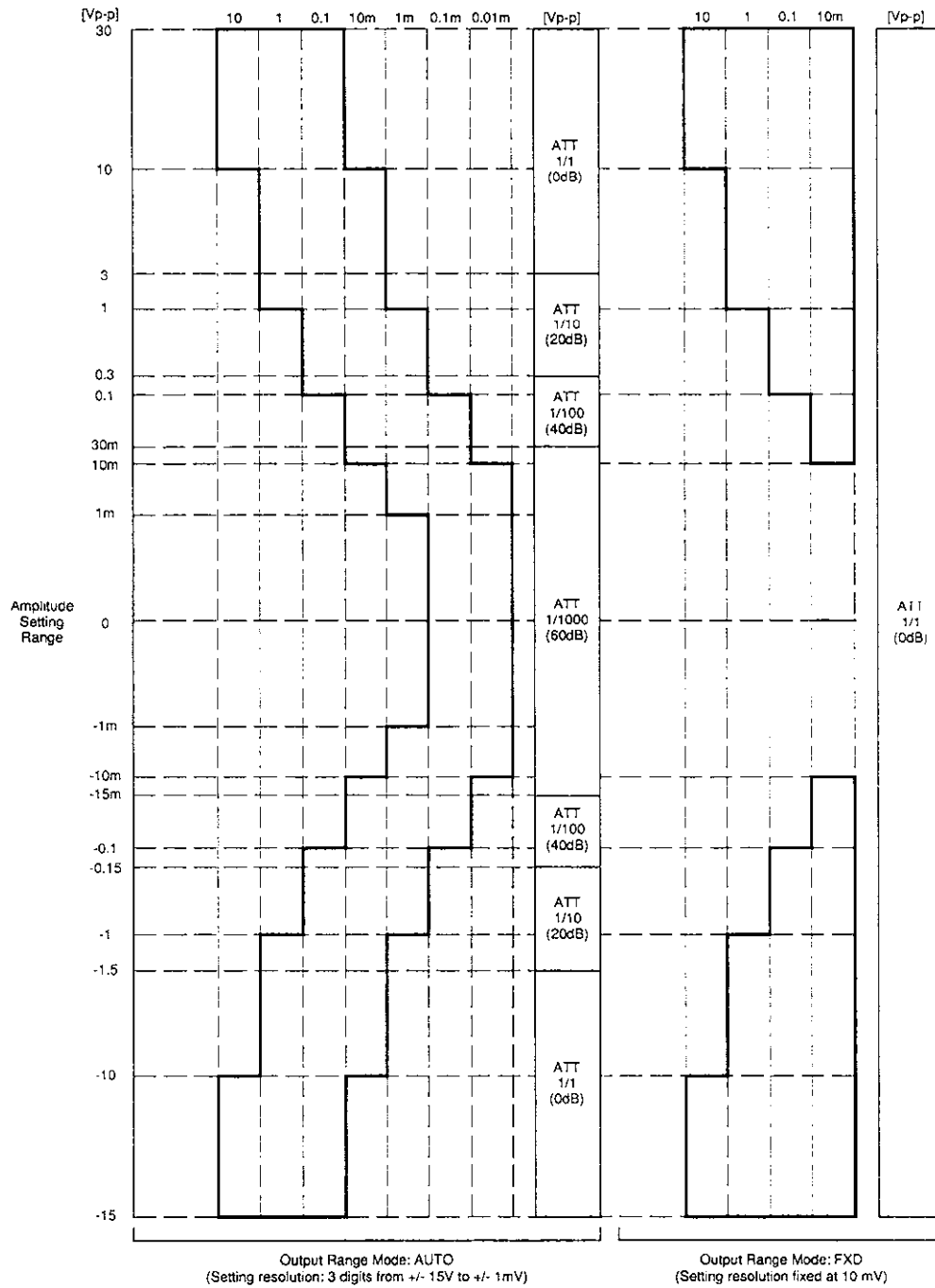

Figure 3-16. Setting Resolution and Number of Digits for DC Only

SECTION 4

GPIB OPERATION

4.1 INTRODUCTION

4.1.1 GPIB Overview

The GPIB interface is a general-purpose interface bus system recognized by the IEEE (Institute of Electrical and Electronics Engineers) in 1975 and is a method of standardizing data transfer between measuring instruments and peripherals. By building each controller and peripheral device into an interface conforming to this standard, it is possible to establish complete hardware compatibility among devices.

Up to 15 devices may be connected to a single interface bus, and data transfer is performed by three handshake lines, enabling reliable data transfer between data senders (talkers) and receivers (listeners) having differing data transfer rates.

4.1.2 Major GPIB Specifications

Overall cable length: 20m maximum
Cable lengths between devices: 4m maximum
Number of devices connectable
(including a controller): 15 maximum
Transfer method: 3-Line handshake
Transfer rate: 1M bytes/sec (maximum)
Data transfer: 8-bit parallel
Signal lines:
 Data bus: 8 Lines
 Control bus: 8 Lines
 (including DAV, NRFD, and NDAC handshake
 lines and ATN, REN, IFC, SRQ, and EOI
 control lines)
Signal/system grounds: 8 Lines
Signal logic: Negative
 True (low-level): 0.8V maximum
 False (high-level): 2.0V minimum

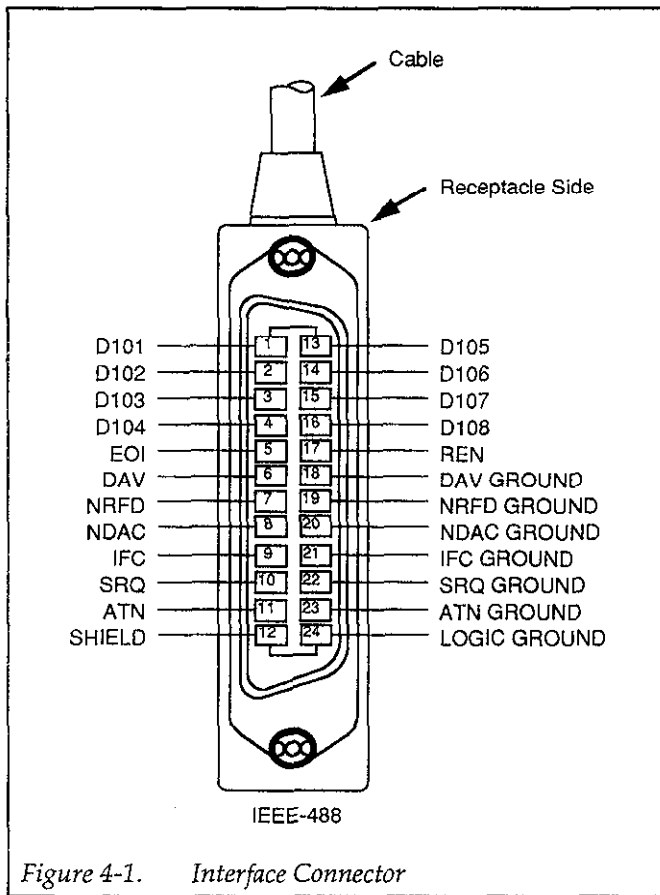

Figure 4-1. Interface Connector

4.1.3 Bus Line Signals and Operation

The GPIB bus consists of 24 lines, including eight data lines, eight control lines, and eight signal/system ground lines.

Data Bus (DIO1 to DIO8)

DIO1 through DIO8 are the data input/output lines, which are used to transfer both address and command information (the type of data present on these lines is determined by the ATN line). DIO1 is the least significant bit (LSB).

Handshake Bus (DAV, NRFD, NDAC)

These three lines are handshake lines used to ensure reliable data transfer.

DAV (DATa Valid)

This line indicates that the data on the DIO lines sent from a talker or the controller are valid.

NRFD (Not Ready For Data)

This line indicates when listeners are ready to accept data over the data lines.

NDAC (Not Data AAccepted)

This line indicates the acceptance of data by listeners.

Control Bus (ATN, REN, IFC, SRQ, EOI)

ATN (ATTeNtion)

This line is an output line from the controller, and it indicates whether the information on the data bus is to be interpreted as data or commands.

REN (Remote ENable)

This output line from the controller switches devices between remote control and local control.

IFC (InterFace Clear)

This output line from the controller clears the interface of active talkers and listeners.

SRQ (Service ReQuest)

This control line is used by a device to request service from the controller. The controller detects this signal and usually executes a serial or parallel poll operation.

EOI (End Or Identify)

This line is used to indicate the end of a multiple-byte transfer sequence or, in conjunction with ATN, to execute a parallel poll operation.

4.1.4 GPIB Handshaking

GPIB handshaking is performed by checking the status of all the listeners and inhibiting the next data transfer until all listeners have completed the reception of data, so that the slowest device on the bus can perform data transfer reliably. The handshaking operations are executed by the following handshake line logic levels:

NRFD = High level: All listeners are ready for accepting data.

DAV = Low level: A talker has valid data on the data bus.

NDAC = High level: All listeners have completed data reception.

The handshaking timing diagram is in Figure 4-2. The various timing points indicate the following:

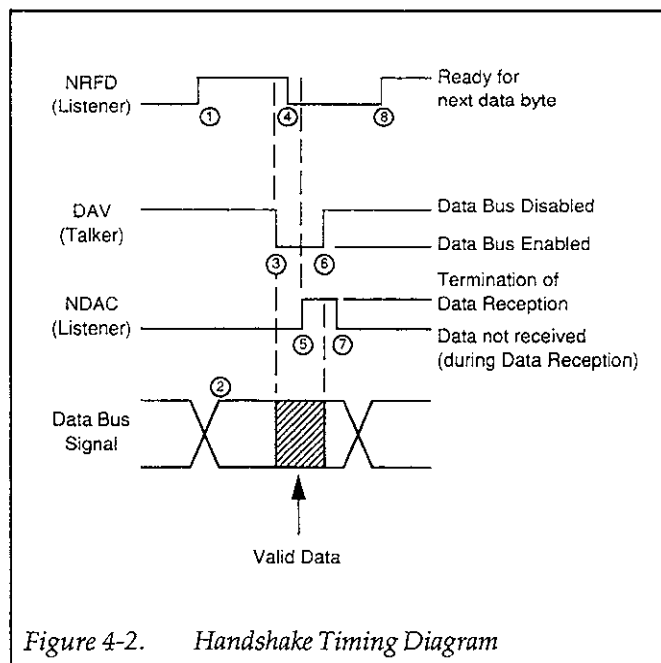

Figure 4-2. Handshake Timing Diagram

- 1 Indicates that all listeners are waiting for data.
- 2 The talker places the data byte to be sent on the data lines. Output may have already occurred.
- 3 The talker checks NRFD, and, if high, DAV is set low to indicate to the listener that data is valid.
- 4 When DAV goes low, the listener reads data, and NRFD is set low, indicating to the talker that data processing is in progress. Each listener sets NDAC high at the completion of data input. The NDAC logic level is the result of ORing the NDAC signals from each listener.

- 5 When all listeners have completed receiving data, NDAC goes high, indicating to the talker that data reception has been completed.
- 6 The talker sets DAV high, indicating to the listener that data on the bus is no longer valid.
- 7 The listener checks to see whether DAV is high and sets NDAC low, completing the handshake.
- 8 Indicates that all listeners have completed data input, and the bus is ready to transfer the next data byte.

4.1.5 Data Transfer Example

Figure 4-3 shows a data transfer example using the three-line handshake process. In this example, the character string "ABC" is sent, followed by the <CR> <LF> delimiter.

4.1.6 Basic Talker Functions

- Only one talker may exist on the GPIB at a time.
- Data is sent to listeners when the controller ATN line is high (false).
- Source handshaking is performed automatically.
- A service request (SRQ) is sent to the controller by other devices.
- The talker function is available with both the local and remote modes.
- The talker function is canceled by any of the following:
 - When the talk address of another device is received.
 - When the device is addressed as a listener.
 - When the untalk (UNT) command is received.
 - When the interface clear (IFC) command is received.

4.1.7 Basic Listener Functions

- Two or more listeners may exist on the GPIB at any time.
- Data is received from a talker when the controller ATN signal is high.
- The acceptor handshake is performed automatically.
- The listener function is canceled by any of the following:
 - When the device is addressed to talk.
 - When the unlisten (UNL) command is received.
 - When the IFC command is received.

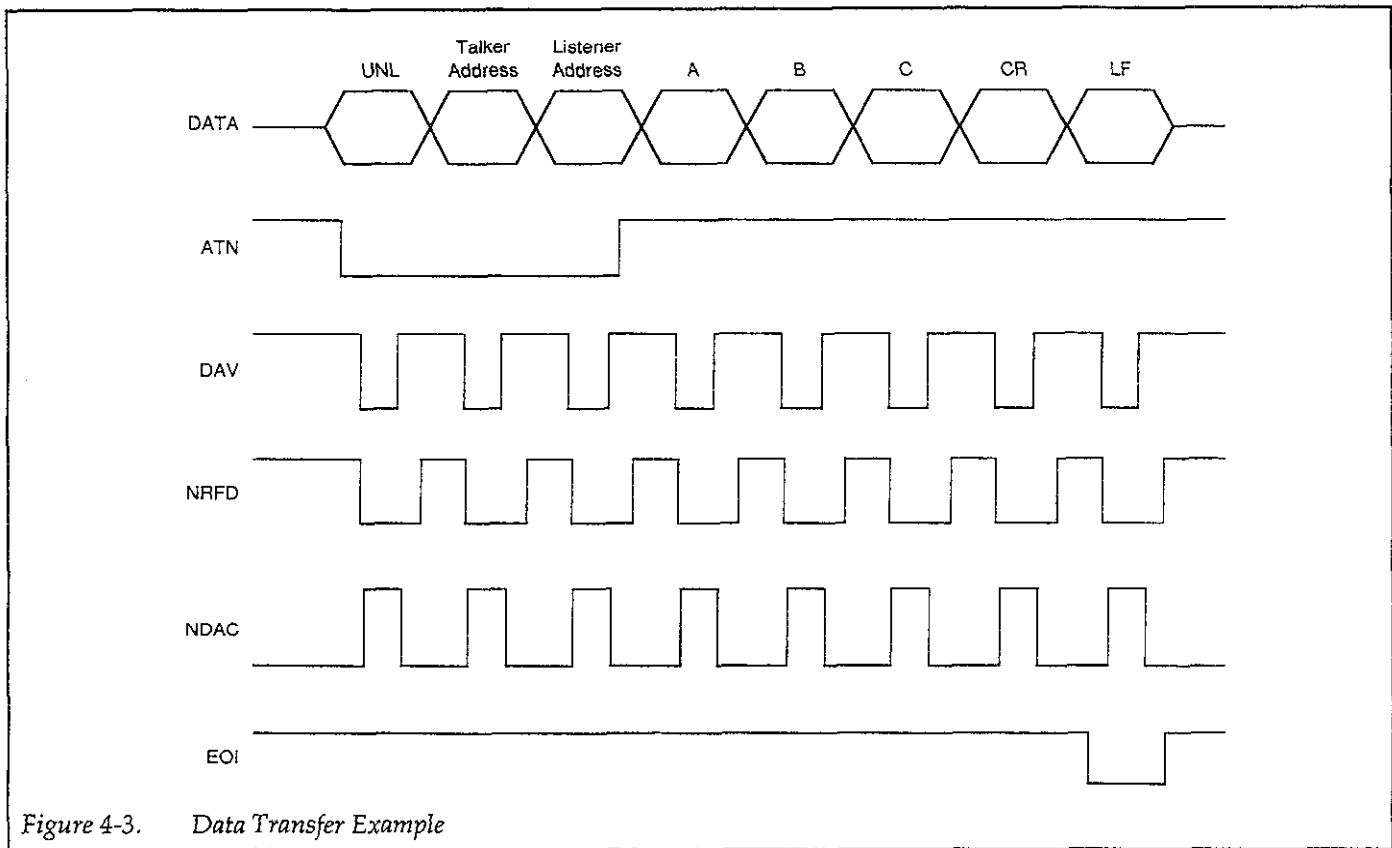

Figure 4-3. Data Transfer Example

4.1.8 Basic Controller Functions

- Only one controller can be active on the GPIB.
- The controller sets the ATN signal to low to address devices to listen and talk, and to transmit commands such as DCL.

- The controller sends single-line commands such as IFC and REN.

4.1.9 Multi-Line Interface Messages

A multi-line interface message is sent over the data lines with ATN set low. Table 4-1 summarizes these messages.

Table 4-1. Multi-line Interface Messages

b7 b6 b5					0	1	0	0	0	1	0	1	0	1	0	1	0	1	0	1	0	1	
b4	b3	b2	b1	COLUMN ROW	0	1	2	3	4	5	6	7	MSG	MSG	MSG	MSG	MSG	MSG	MSG	MSG	MSG	MSG	
0	0	0	0	0	NUL		DLE		SP														
0	0	0	1	1	SOH	GTL	DC1	LLO	!														
0	0	1	0	2	STX		DC2		*														
0	0	1	1	3	ETX		DC3		#														
0	1	0	0	4	EOT	SDC	DC4	DCL	\$														
0	1	0	1	5	ENQ	PPC ³	NAK	PPU	%														
0	1	1	0	6	ACK		SYN		&														
0	1	1	1	7	BEL		ETB		'														
1	0	0	0	8	BS	GET	CAN	SPE	(
1	0	0	1	9	HT	TCT	EM	SPD)														
1	0	1	0	10	LF		SUB		.														
1	0	1	1	11	VT		ESC		+														
1	1	0	0	12	FF		FS		,														
1	1	0	1	13	CR		GS		-														
1	1	1	0	14	SO		RS		.														
1	1	1	1	15	SI		US		/														

ADDRESSED COMMAND GROUP (ACG)	UNIVERSAL COMMAND GROUP (UCG)	LISTEN ADDRESS GROUP (LAG)	TALK ADDRESS GROUP (TAG)
PRIMARY COMMAND GROUP (PCG)		SECONDARY COMMAND GROUP (SDC)	

- NOTES
- 1 MSG IS THE INTERFACE MESSAGE
 - 2 b1 = DIO8 . . . b2 = DIO7
DIO8 IS NOT USED
 - 3 HAS SECONDARY COMMAND

4.2 OVERVIEW OF MODEL 3930A GPIB INTERFACE

Bus Driver

Table 4-3 gives the bus driver specifications.

4.2.1 Introduction

The Model 3930A GPIB interface has a wide variety of interface functions. These functions allow remote the setting of most of the parameters which can be set from the front panel. The interface can also transfer setting data and conditions to an external device, enabling the user to easily configure a sophisticated automatic measurement system.

Setting data and conditions are sent to the controller as character strings in ASCII format.

Table 4-3. Bus Driver Specifications

DIO1 to DIO8 NDAC, NRFD, SRQ	Open Collector
DAV EOI	Three-state

Codes

Codes which can be received by the Model 3930A in listener mode are in 7-bit ASCII format (bit 7 is ignored). Codes can be sent using either lower-case or upper-case letters. In either case, codes are interpreted and executed identically. The space (20H), tab (09H), null (00H), and semicolon ";" (3BH) characters are ignored.

Talker (inquiry) mode transmission codes are also in 7-bit ASCII format. All letter characters are sent as upper-case letters.

4.2.2 Specifications

GPIB Primary Address

The GPIB address of the Model 3930A is set by the front panel GPIB key. Set values are stored in battery backed up memory when the power is turned off. For details on setting the primary address, see **8** in paragraph 3.2.1.

Interface Functions

The factory default value for the primary address is 2.

Table 4-2 shows the interface functions of the Model 3930A.

Table 4-2. Interface Functions

Function	Subset	Explanation
Source Handshake	SH1	Full source handshake capabilities
Acceptor Handshake	AH1	Full acceptor handshake capabilities
Talker	T6	Basic talker functions, serial poll, unaddressed by MLA
Listener	L4	Basic listener functions, unaddressed by MTA
Service Request	SR1	Full service request capabilities
Remote/Local	RL1	Full remote/local capabilities
Parallel Poll	PP0	No parallel poll capabilities
Device Clear	DC1	Full device clear capabilities
Device Trigger	DT0	No device trigger capabilities
Controller	C0	No controller capabilities

Delimiter

The Model 3930A recognizes <CR>, <LF>, or <EOI> in any combination as a delimiter for receiving code strings in the listener mode.

The delimiter used when sending a response in the talker mode is set from the front panel with the GPIB key. Only <CR> or <CR><LF> can be selected as an output delimiter, and EOI is sent simultaneously. For information on delimiter selection, see 8 in paragraph 3.2.1. The factory default delimiter is <CR><LF> ^ EOI.

Response to Interface Messages

Table 4-4 summarizes Model 3930A responses to interface messages.

Table 4-4. Response to Interface Messages

IFC	Initializes GPIB interface. Releases specified listener and talker modes.
DCL and SDC	Clears GPIB input/output buffer. Clears error status. Releases SRQ transmission and resets SRQ causes (unit's operating modes do not change).
LLO	Disables front panel LOCAL key.
GTL	Goes into local mode (front panel programming enabled).

Program Codes

Program codes used for the various settings of the Model 3930A are temporarily stored in the input buffer as received. When a delimiter is received, they are interpreted and executed in the order received. The input buffer can store up to 128 characters (128 bytes). Note that space, tab, null, semicolon, and delimiter characters are not stored in the input buffer.

When more than 128 program code characters are received, the input buffer overflows. When an overflow occurs, the input buffer is cleared, and program codes stored in the buffer are not executed.

In addition, the input buffer is cleared, and subsequent program codes are not executed when an illegal header or parameter is found during the interpretation of a program code.

When interpretation and execution are completed, the input buffer is cleared, and the unit is ready to receive the next program code.

As shown in Figure 4-4, program codes consists of a header and a parameter. More than one program code can be sent at a time, up to a maximum of 128 characters. Multiple program codes can be separated by a space or semicolon (;) to improve readability.

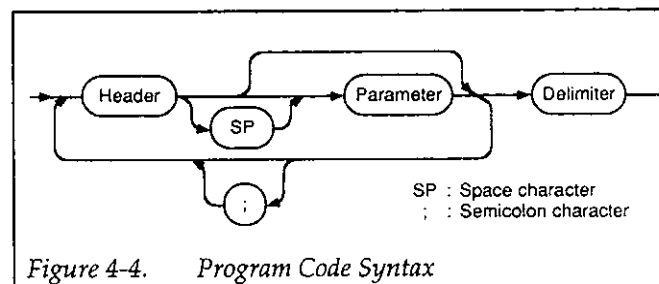

Figure 4-4. Program Code Syntax

There are two general types of program codes: parameter-setting messages and inquiry messages. Parameter-setting messages are used for setting parameters or for sending operating instructions. Inquiry messages are used for requesting state and parameter setting information from the instrument.

Parameter Setting Messages

The format of a basic setting message is shown below. In this example, the frequency is set to 1.0kHz, and the amplitude is set to 1.0Vp-p.

FRQ 1.0E+03 AMV 1.0E+00
 a b c d e b a b c d b e

- a: Indicates the three-letter alphabetic character header. Either upper-case or lower-case letters can be used.
- b: Indicates a space character inserted for readability. There is no limit on the number of spaces, and the space can be omitted. Space, tab, null, and semicolon characters are ignored and are not stored in the GPIB input buffer.

- c: Indicates the parameter mantissa. The mantissa includes a polarity sign (+ or -), numeric value, and decimal point. When the polarity sign is omitted, the plus sign (+) is assumed. Parameters are described in detail in the following paragraph.
- d: Indicates the exponent. Depending on the type of program code, an exponent may not be included with the parameter.
- e: Indicates the semicolon used to separate program codes for readability. There is no limit on the number of semicolons, and the semicolon can be omitted. The semicolon is also ignored and is not stored in the GPIB input buffer.

Numeric Format of Parameter-Setting Messages

The three formats described below are used for the various parameter-setting messages.

NR1 Format

In the NR1 format, numeric values are specified as integers. No decimal point is used in this format. The decimal point is assumed to be at the end of the last character.

+DDDD

- 
- Leading zeroes and spaces are ignored
 - Sign (+ for positive, - for negative, + is assumed if sign is omitted).

Examples: +01234
-500
18

NR2 Format

In the NR2 format, numeric values are specified as real numbers. NR2 numeric values include a decimal point, but digits to the right of the decimal point can be omitted.

+DD.DD

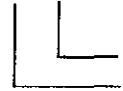
- 
- Leading zeroes and spaces are ignored
 - Sign (+ for positive, - for negative, + is assumed if sign is omitted).

Examples: +012.34
-50.0
1.8

NR3 Format

In the NR3 format, numeric values are specified in exponential form. The exponent character, E, and subsequent sign and numbers can be omitted. When the exponent is omitted, E+00 is assumed, and the value is handled as an NR2 format parameter.

+DD.DD E++DD

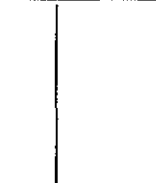
- 
- Leading zeroes and spaces are ignored
 - Sign (+ for positive, - for negative, + is assumed if sign is omitted).
 - Same as NR2 format.

Examples: +012.34E+03
-50.0E-06
1.8E-09

Inquiry Messages

An inquiry message is a special program code with a question mark (?) located at the beginning. An inquiry message is used to request information from the instrument regarding a state or particular parameter setting.

Except for special cases, each inquiry message corresponds to an equivalent parameter-setting message. Inquiry messages include only the header and a question mark; no parameters are used.

After receiving an inquiry message, the Model 3930A searches for the corresponding setting and places the response in its output buffer. When it is addressed to talk, it sends that setting information to the controller.

The response output format is the same as the format of the corresponding setting message, as shown in Figure 4-5. The format for inquiries without corresponding messages are discussed below.

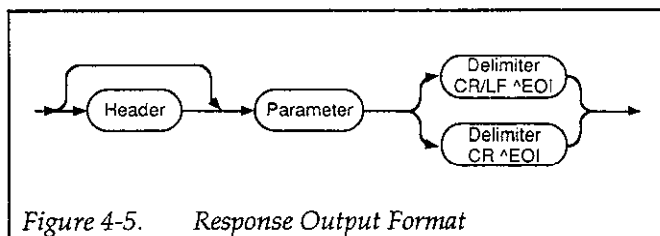

Figure 4-5. Response Output Format

When more than one inquiry is sent to the Model 3930A at the same time, only the last request is accepted, and previous requests are ignored. When a new inquiry is received before the response for a previous request is completed, the new request over-rides the previous request.

NOTES:

1. The header in the inquiry response string can be turned on or off by sending the command "HDR 1" or "HDR 0" respectively. The power-on default header state is header on ("HDR 1").
2. Either <CR><LF>^EOI or <CR>^EOI can be selected as the inquiry response delimiter. The delimiter can be programmed with the front panel GPIB

key; see **8** in paragraph 3.2.1. The factory default delimiter is <CR><LF>^EOI.

Numeric Format of Inquiry Message Response Parameters

As described below, three different formats are used for inquiry response parameters.

NR1 Inquiry Response Format

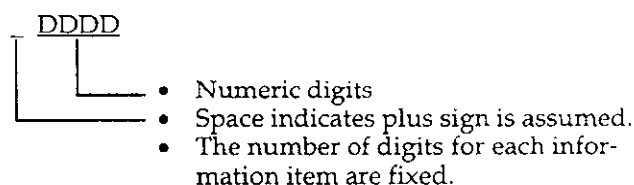

Example: FNC 1

(Indicates the output waveform is \sim . Header: three characters, space indicating sign: one character, numeric parameter: one character. Total: five characters.)

NR2 Inquiry Response Format

In the NR2 format, inquiry response parameters are specified as real numbers:

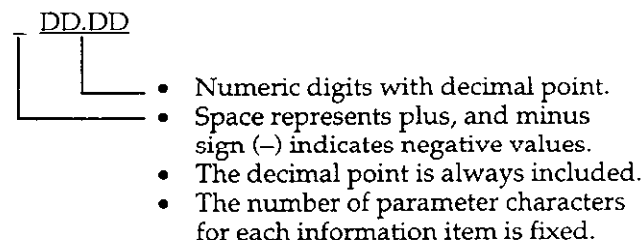

Example: DTY 25.0

(Indicates that the square-wave duty cycle is set to 25%. Header: three characters, space indicating sign: one character, numeric parameter including decimal point: four characters. Total: eight characters.)

NR3 Inquiry Response Format

In the NR3 format, parameters are specified in exponential form:

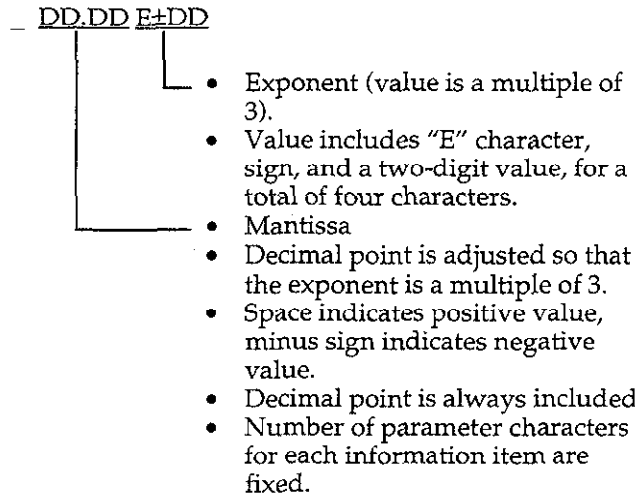

Example: STM 1.000E+00
 (Indicates a one-second sweep time. Header: three characters, space indicating sign: one character, mantissa including decimal point: five characters, exponent: four characters. Total: 13 characters.)

Service Request (SRQ)

The Model 3930A can request service from the controller via the SRQ line under the following conditions:

- An error condition occurs
- A sweep stops
- A sweep starts
- The output is ready with an inquiry response.

When the controller detects an SRQ from the Model 3930A and performs a serial poll, the Model 3930A transfers the status byte and clears the SRQ signal line (set high). Table 4-5 summarizes status byte conditions.

The status byte can be read using serial polling or by sending "?STS". When the status byte is read, the following bits are reset (cleared): bit 6 (RQS), bit 5 (error), bit 2

(SWEEP stop), bit 1 (SWEEP start), and bit 0 (output ready). Note, however, that corresponding masked SRQ bits cannot be reset.

Bits in the status byte can be masked so that those particular conditions will not cause an SRQ to occur. To mask bits, set the corresponding bits to 1 by adding up the decimal bit values and sending them with the "MSK" program code. For instance, to disable SRQ by masking the SWEEP stop (bit 2), SWEEP start (bit 1), and output ready (bit 0), send the command "MSK 7" ($2^2 + 2^1 + 2^0 = 7$). When these bits are masked, an SRQ will not occur at sweep stop or sweep start, or for output ready.

Bit 7 (unused), bit 4 (HOLD), and bit 3 (SWEEP in execution) cannot cause an SRQ. Therefore, setting or resetting these bits has no effect on SRQ generation.

If SRQ is not masked, an SRQ is generated even when the unit is in the LOCAL mode. At power-on, all SRQ conditions are masked (MSK 63).

Error Codes

Error codes indicate what kind of error has occurred. As each error occurs, an error code is updated, and the latest error information is always available. Error codes can be read by sending the "?ERR" inquiry. An error code is cleared when read and when a DCL or SDC command is received.

The status byte error bit (bit 5) is reset (0) when an error code cleared. When an attempt is made to read an error code by sending "?ERR" after the code is cleared, "ERR-01" is returned to indicate that the error code has been cleared.

Other returned error codes assume the same numbers as the corresponding display error code numbers, which are covered in paragraph 3.5.3 in Section 3.

4.3 MODEL 3930A PROGRAM CODES

4.3.1 Model 3930A Parameter-Setting Messages

Table 4-5. Status Byte

Bit	Description	Set (1) Condition	Reset (0) Condition
(MSB) 7	0	Always 0 (not used)	Always 0 (not used)
6	RQS	<ul style="list-style-type: none"> When SRQ is issued. 	<ul style="list-style-type: none"> When status byte is sent. When DCL or SDC is received. When SRQ cause is cleared by setting SRQ mask bits.
5	Error (SRQ cause)	<ul style="list-style-type: none"> When an error occurs. 	<ul style="list-style-type: none"> When error code is requested and sent using "?ERR". When status byte is sent. When DCL or SDC is received.
4	HOLD	<ul style="list-style-type: none"> When sweep is interrupted due to sweep "HOLD". 	<ul style="list-style-type: none"> When sweep is restarted due to "HOLD" release. When sweep is started during "HOLD". When sweep is turned off.
3	SWEEP in execution	<ul style="list-style-type: none"> When sweep is started by sweep start. When sweep is restarted by releasing "HOLD". 	<ul style="list-style-type: none"> When sweep is halted due to the end of single sweep or sweep off. When sweep is paused by "HOLD".
2	SWEEP stop (SRQ cause)	<ul style="list-style-type: none"> When sweep is halted due to end of single sweep or sweep off. When sweep is stopped by "HOLD". 	<ul style="list-style-type: none"> When status byte is sent. When DCL or SDC is received.
1	SWEEP start (SRQ cause)	<ul style="list-style-type: none"> When sweep is started by sweep start. When sweep is restarted by releasing "HOLD". 	<ul style="list-style-type: none"> When status byte is sent When DCL or SDC is received
(LSB) 0	Output ready (SRQ cause)	<ul style="list-style-type: none"> When inquiry response data is ready for output. 	<ul style="list-style-type: none"> When status byte is sent. When talker is addressed. When next inquiry message is received. When DCL or SDC is received

Table 4-6. Model 3930A Main Parameter Setting Messages

Function	Program Code		Operation and Setting Range	Inquiry
	Header	Parameter		
<u>F</u> REQUENCY	FRQ	NR3	Sets oscillation frequency (frequency: Hz) Range: 0.1E-03 (0.1mHz) to 1.2E+06 (1.2MHz) Resolution: 0.1mHz Example: FRQ 1.0E + 2 (100Hz)	Yes
<u>P</u> ERIOD	PRD	NR3	Sets oscillation frequency by period (period: s) Range: 0.84E-06 (0.8 4μs = 1.19MHz) to 10.0E+03 (10000s = 0.1mHz) Resolution: 0.01 μs Example: PRD 1.0E+00 (1s = 1Hz)	Yes
<u>A</u> MPLITUDE Vp-p	AMV	NR3	Sets output amplitude (Vp-p) Range: In AUTO output range mode: 0.3E-03 (0.3mVp-p) to 30.0E+00 (30Vp-p) In FXD output range mode: 0.00E+00 (0Vp-p) to 30.00E+00 (30Vp-p) Resolution: In AUTO output range mode: 0.01mVp-p In FXD output range mode: 10mVp-p Example: AMV 2.0E+00 (2Vp-p)	Yes
<u>A</u> MPLITUDE (Vrms) (Only when output range mode is AUTO)	AMR	NR3	Sets output amplitude (Vrms). Range: For sine wave: 0.11E-03 (0.11mVrms) to 10.6E+00 (10.6Vrms) For sawtooth or triangular: 0.09E-03 (0.09mVrms) to 8.66E+00 (8.66Vrms) For square wave: 0.15E-03 (0.15mVrms) to 15.0E+00 (15.0Vrms) Resolution: 0.01mVrms Example: AMR 7.1E+0 (7.1Vrms)	Yes
<u>A</u> MPLITUDE (dBV) (Only when output range mode is AUTO)	AMD	NR3	Sets output amplitude (dBV). Range: For sine wave: -79.2E+00 (-79.2dBV) to 20.5E+00 (20.5dBV) For sawtooth or triangular: -80.9E+00 (-80.9dBV) to 18.8E+00 (18.8dBV) For square wave: -76.5E+00 (-76.5dBV) to 23.5E+00 (23.5dBV) Resolution: 0.1dBV Example: AMD -10.5E+0 (-10.5dBV)	Yes

Model 3930A Main Synthesizer Parameter Setting Messages (Cont.)





Function	Program Code		Operation and Setting Range	Inquiry
	Header	Parameter		
<u>OFFSET</u>	OFS	NR3	Sets DC offset V Range: In AUTO output range mode: -15.0E+00 (-15V) to 15.0E+00 (15V) In FXD output range: -15.0E+00 (-15V) to ~15.0E+00 (15V) Resolution: In AUTO output range mode: 0.01mV In FXD output range mode: 10mV Example: OFS 4.56E-1 (0.456V)	Yes
<u>FUNCTION</u>	FNC	NR1	Selects output waveform. Range: 0 to 5 0: DC 1:  2:  3:  4:  5:  Example: FNC 1 (sine wave)	Yes
<u>MODE</u>	MOD	NR1	Sets oscillation mode. Range: 0 to 2 0: CONT (continuous) 1: BRST (burst) 2: GATE Example: MOD 0 (CONT)	Yes

Table 4-7. Model 3930A Trigger Parameter Setting Messages

Function	Program Code		Operation and Setting Range	Inquiry
	Header	Parameter		
TRIGGER SOURCE	TRS	NR1	Selects trigger source. Range: 0 to 3 0: EXT <input type="checkbox"/> 1: EXT <input checked="" type="checkbox"/> 2: INT <input type="checkbox"/> 3: INT <input checked="" type="checkbox"/> Example: TRS 2 (triggered by <input checked="" type="checkbox"/> of INT TRIG GEN)	Yes
REMOTE TRIGGER	TRG	NR1	Function equivalent to pressing front panel MAN key. Valid only when trigger source is EXT. Burst: Trigger occurs at changes from TRG 0 to TRG 1. Gate: Gate off with TRG 0 and gate on with TRG 1. Range: 0 or 1 0: Trigger inactive (Same as MAN key off) 1: Trigger active (Same as MAN key on) Example: TRG 1	Yes
EXT TRIG IN BNC ENABLE	TRE	NR1	Selects whether or not front panel EXT TRIG IN connector is enabled in remote mode. (Enabled when trigger source is EXT with TRE 1. Always enabled in local; when the unit returns to remote, the status of the previous remote mode is placed into effect. Initial status at power up or when PST code has been executed is TRE 1.) Range: 0 or 1 0: In remote mode, EXT TRIG IN is disabled 1: In remote mode, EXT TRIG IN is enabled Example: TRE 1	Yes
INT TRIG GENERATOR TRIG RATE	TRR	NR3	Set internal trigger generator by period. Range: 1.0E-06 (1 μ s) to 2.9999E+03 (2999.9s) Resolution: 1 μ s Example: TRR 1.0E-3 (1ms)	Yes

Model 3930A Trigger Parameter Setting Messages (Cont.)

Function	Program Code		Operation and Setting Range	Inquiry
	Header	Parameter		
INT TRIG GENERATOR TRIG FREQUENCY	TRF	NR3	Sets oscillation cycle of trigger generator by frequency. Range: 0.4E-03 (0.4mHz = 2500s) to 1.0E+06 (1MHz = 1 μs) Resolution: 0.1mHz Example: TRF 1.25E+03 (1.25kHz = 0.8ms)	Yes
BURST COUNT	BST	NR1	Sets number of burst cycles. Range: 1 to 65536 Example: BST 10 (10 cycles)	Yes
START/STOP PHASE	SPH	NR2	Start/stop phase setting (°: degrees) Range: -360.0 to 360.0 (-360° to 360°) Resolution: 0.1° Example: SPH 180.0 (180°)	Yes

Table 4-8. Model 3930A Sweep Parameter Setting Messages

Function	Program Code		Operation and Setting Range	Inquiry
	Header	Parameter		
SWEEP <u>S</u> TART <u>F</u> REQUENCY	STF	NR3	Sets sweep start frequency (Frequency: Hz). Range: 0.1E-03 (0.1mHz) to 1.2E+06 (1.2MHz) Resolution: 0.1mHz Example: STF 1.0E+2 (100Hz)	Yes
SWEEP <u>S</u> TOP <u>F</u> REQUENCY	SPF	NR3	Sets sweep stop frequency (frequency: Hz). Range: 0.1E-03 (0.1mHz) to 1.2E+06 (1.2MHz) Resolution: 0.1mHz Example: SPF 1.0E+2 (100Hz)	Yes
SWEEP <u>C</u> ENTER <u>F</u> REQUENCY	CTF	NR3	Sets sweep center frequency (frequency: Hz). Range: 0.1E-03 (0.1mHz) to 1.2E+06 (1.2MHz) Resolution: 0.1mHz Example: CTF 1.0E+2 (100Hz)	Yes
SWEEP <u>S</u> PAN <u>F</u> REQUENCY	SNF	NR3	Sets sweep frequency span (frequency: Hz). Range: 0.1E-03 (0.1mHz) to 1.9999999999E+06 (1.2MHz - 0.1mHz) Resolution: 0.1mHz Example: SNF 1.0E+2 (100Hz)	Yes
SWEEP <u>M</u> ARKER <u>F</u> REQUENCY	MKF	NR3	Sets sweep marker frequency (frequency: Hz). Range: 0.1E-03 (0.1mHz) to 1.2E+06 (1.2MHz) Resolution: 0.1mHz Example: MKF 1.0E+2 (100Hz)	Yes
SWEEP <u>S</u> TART <u>P</u> ERIOD	STD	NR3	Sets sweep start frequency by period (period:s). Range: 0.86E-06 (0.86 μ s = 1.19MHz) to 10.0E+03 (10000s = 0.1mHz) Resolution: 0.01 μ s Example: STD 1.00E+00 (1s = 1Hz)	Yes
SWEEP <u>S</u> TOP <u>P</u> ERIOD	SPD	NR3	Sets sweep stop frequency by period (period: s). Range: 0.86E-06 (0.86 μ s = 1.19MHz) to 10.0E+03 (10000s = 0.1mHz) Resolution: 0.01 μ s Example: SPD 1.00E+00 (1s = 1Hz)	Yes

Main Synthesizer Sweep Parameter Setting Messages (Cont.)

Function	Program Code		Operation and Setting Range	Inquiry
	Header	Parameter		
<u>SWEEP CENTER PERIOD</u>	CTD	NR3	Sets sweep center frequency by period (period: s). Range: 0.86E-06 (0.86 μ s = 1.19MHz) to 10.0E+03 (10000s = 0.1mHz) Resolution: 0.01 μ s Example: CTD 1.00E+00 (1s = 1Hz)	Yes
<u>SWEEP SPAN PERIOD</u>	SND	NR3	Sets sweep span frequency by period (period: s). Range: 0.86E-06 (0.86 μ s = 1.19MHz) to 10.0E+03 (10000s = 0.1mHz) Resolution: 0.01 μ s Example: SND 1.00E+00 (1s = 1Hz)	Yes
<u>SWEEP MARKER PERIOD</u>	MKD	NR3	Sets sweep marker frequency by period (period: s). Range: 0.86E-06 (0.86 μ s = 1.19MHz) to 10.0E+03 (10000s = 0.1mHz) Resolution: 0.01 μ s Example: MKD 1.00E+00 (1s = 1Hz)	Yes
<u>CENTER FROM MARKER</u>	CFM	None	Assigns marker frequency to center frequency (assigns marker period to center period).	No
<u>SWEEP TIME</u>	STM	NR3	Sets sweep time (s). Range: 5.0E-03 (5ms) to 9.999E+03 (9999s) Resolution: 1ms Example: STM 1.0E+00 (1s)	Yes
<u>SWEEP FUNCTION</u>	SFN	NR1	Selects sweep function. Range: 0 to 4 0: \square 1: Lin \wedge 2: Lin \nearrow 3: Log \wedge 4: Log \searrow Example: SFN 2 (LIN \nearrow)	Yes
<u>SWEEP OFF</u>	SOF	None	Disables sweep.	No
<u>SWEEP CONTINUOUS START</u>	SCN	None	Starts continuous sweep.	No
<u>SWEEP SINGLE START</u>	SSG	None	Starts single sweep.	No

Model 3930A Sweep Parameter Setting Messages (Cont.)

Function	Program Code		Operation and Setting Range	Inquiry
	Header	Parameter		
<u>S</u> INGL <u>S</u> TART <u>B</u> N <u>C</u> <u>E</u> NABLE	SGE	NR1	Enables/disables rear panel SINGL START IN connector when unit is in remote. (SGE 1: enables SINGL START IN in remote and single sweep is generated when signal is applied to SINGL START IN. In local mode, this connector is always enabled. When the unit is placed in remote, the previous remote status of SINGL START IN is placed into effect. Initial status at power-up or when PST code has been executed is SGE 1.) Range: 0 or 1 0: SINGL START IN is disabled in remote. 1: SINGL START IN is enabled in remote. Example: SGE 1	Yes
<u>S</u> WEEP <u>S</u> TART <u>S</u> TATE	SST	None	Outputs start frequency. (If this command is issued during a sweep, the sweep halts, and the start frequency is output.)	No
<u>S</u> WEEP <u>S</u> TOP <u>S</u> TATE	SSP	None	Outputs stop frequency. (If this command is given during a sweep, the sweep halts, and the stop frequency is output.)	No
<u>S</u> WEEP <u>H</u> OLD	HLD	None	Temporarily halts sweep.	No
<u>S</u> WEEP <u>R</u> ESUME	RSM	None	Restarts sweep. (When RSM is sent when the unit is not in HOLD, the command is ignored, and no error occurs.)	No
<u>H</u> OLD <u>I</u> N <u>B</u> N <u>C</u> <u>E</u> NABLE	HLE	NR1	Enables/disables rear panel SWEEP HOLD IN connector when unit is in remote. (HOLD IN is always enabled in local; when the unit returns to remote, the status of this connector while previously in remote is placed into effect. Initial status at power up or when PST code has been executed is HLE 1.) Range: 0 or 1 0: HOLD IN is disabled when unit is in remote 1: HOLD IN is enabled when unit is in remote. Example: HLE 0	Yes

NOTE: When the HOLD IN connector is enabled, (HLE 1), the HLD and RSM program codes have the following effects:

1. When a low logic level is applied to the HOLD IN connector, the sweep goes into the hold mode, and the HLD and RSM codes have no effect. The sweep restarts when the HOLD IN signal is set high.
2. When a sweep has been halted by the HLD command, the HOLD IN connector signal is disabled, and the sweep resumes when a RSM is issued.

Table 4-9. Model 3930A Miscellaneous Parameter Messages

Function	Program Code		Operation and Setting Range	Inquiry
	Header	Parameter		
<u>A</u> MPLITUDE <u>M</u> ODULATION ON/OFF	AMM	NR1	AM on/off. Range: 0 or 1 0: Off 1: On Example: AMM 0	Yes
<u>D</u> UTY CYCLE	DTY	NR2	Square wave duty cycle (%). Range: 5.0 to 95.0 (5.0% to 95.0%) Resolution: 0.1% Example: DTY 12.5 (12.5%)	Yes
<u>D</u> UTY CYCLE <u>F</u> IXED	DYF	None	Square wave duty cycle fixed at 50%. Example: DYF	No
<u>M</u> EMORY <u>S</u> TORE	STO	NR1	Stores instrument settings in memory. Range: 0 to 9 (memory number) Example: STO 1	No
<u>M</u> EMORY <u>R</u> ECALL	RCL	NR1	Recalls instrument settings from memory. Range: 0 to 9 (memory number) Example: RCL 9	No
<u>D</u> ISPLAY	DSP	None	Displays main parameters. Example: DSP	No
<u>P</u> RESET	PST	None	Sets preset mode. Example: PST	No
<u>F</u> UNCTION <u>O</u> UTPUT ON/OFF	FNO	NR1	Turn waveform output on/off. Range: 0 or 1 0: Off 1: On Example: FNO 1 (on)	Yes
<u>O</u> UTPUT RANGE <u>M</u> ODE	OMD	NR1	Select output range mode. Range: 0 or 1 0: Automatic (AUTO) 1: Fixed (FXD) Example: OMD 1 (FXD)	Yes

Table 4-10. Parameter Messages Specific to Model 3930A GPIB

Function	Program Code		Operation and Setting Range	Inquiry
	Header	Parameter		
HEADER ON/OFF	HDR	NR1	Selects on/off for header in inquiry response message. Range: 0 or 1 0: No header in inquiry response (off). 1: Include header in inquiry response (on). Example: HDR 1 (on)	Yes
SRQ MASK	MSK	NR1	Sets SRQ mask bits. Range: 00 to 63 32: Error occurred. 32: No SRQ sent when error occurs. 0: Send SRQ when error occurs. 16: No effect. (same as 0.) 8: No effect. (same as 0.) 4: SWEEP stop. 4: No SRQ sent when SWEEP stops. 0: Send SRQ when SWEEP stops. 2: SWEEP starts. 2: No SRQ sent when SWEEP starts. 0: Send SRQ when SWEEP starts. 1: Output buffer ready with response to inquiry message. 1: No SRQ sent when output buffer is ready. 0: Send SRQ when output buffer is ready. Add sum of above noted SRQ bits for multiple SRQ conditions. Example: MSK 6 (6 = 4 + 2: No SRQ sent at SWEEP stop or SWEEP start. SRQ sent with error and output ready.)	Yes

4.3.2 Model 3930A Inquiry Messages

When the header is on (HDR 1), each inquiry response will include a three-character identifying mnemonic.

When the header is off (HDR 0), the mnemonic not sent, and only the parameter itself is transmitted. Each parameter begins with a space or minus sign (-) to indicate polarity.

Table 4-11. Main Parameter Inquiry Messages

Inquiry Description	Program Code	Response Format	Setting
<u>F</u> REQUENCY Oscillation frequency inquiry (frequency: Hz)	?FRQ	NR3 format: 11-digit mantissa, 2-digit exponent. Example: FRQ 1000.0000000E+03 (1MHz)	Yes
<u>P</u> ERIOD Oscillation period inquiry (Period: s)	?PRD	NR3 format: 6-digit mantissa, 2-digit exponent. Example: PRD 3.33333E-03 (3.33333ms = 300Hz)	Yes
<u>A</u> MPLITUDE (V _{p-p}) Output amplitude inquiry (V _{p-p})	?AMV	NR3 format: In AUTO output range: 3-digit mantissa, 2-digit exponent In FXD output range: 4-digit mantissa, 2-digit exponent Example: AMV 10.0E+00 (10V _{p-p})	Yes
<u>A</u> MPLITUDE (V _{rms}) Output amplitude inquiry (V _{rms}) (AUTO output range mode only)	?AMR	NR3 format: 3-digit mantissa, 2-digit exponent. Example: AMR 1.23+00 (1.23V _{rms})	Yes
<u>A</u> MPLITUDE (dBV) Output amplitude inquiry (dBV) (AUTO output range mode only)	?AMD	NR3 format: 3-digit mantissa, 2-digit exponent Example: AMD 01.0E+00 (1dBV)	Yes
<u>O</u> FFSET DC offset voltage inquiry (V)	?OFS	NR3 format: In AUTO output range mode: 3-digit mantissa, 2-digit exponent In FXD output range mode: 4-digit mantissa, 2-digit exponent Example: OFS -12.3E+00 (-12.3V)	Yes
<u>F</u> UNCTION Output waveform inquiry	?FNC	NR1 format: 1 digit, same as setting value. Example: FNC 1 (Sine wave)	Yes
<u>M</u> ODE Oscillation mode inquiry	?MOD	NR1 format: 1 digit, same as setting value. Example: MOD 0 (CONT)	Yes

Table 4-12. Model 3930A Trigger Parameter Inquiry Messages

Inquiry Description	Program Code	Response Format	Setting
<u>TRIGGER SOURCE</u> Trigger source inquiry	?TRS	NR1 format: 1 digit, same as setting value. Example: TRS 2 (INT $\sqrt{}$)	Yes
REMOTE <u>TRIGGER</u> Inquiry as to whether or not remote trigger is enabled.	?TRG	NR1 format: 1 digit, same as setting value. Example: TRG 0 (Disabled)	Yes
EXT <u>TRIG IN BNC ENABLE</u> Inquiry as to whether or not front panel EXT TRIG IN connector is enabled in remote.	?TRE	NR1 format: 1 digit, same as setting value. Example: TRE 1 (enabled)	Yes
INT TRIG GENERATOR <u>TRIG RATE</u> Inquiry of internal trigger oscillator period.	?TRR	NR3 format: 5-digit mantissa, 2-digit exponent Example: TRR 062.50E-03 (62.5ms)	Yes
INT TRIG GENERATOR <u>TRIG FREQUENCY</u> Inquiry of internal trigger oscillator frequency.	?TRF	NR3 format: 5-digit mantissa, 2-digit exponent Example: TRF 9.8765E+00 (9.8765Hz)	Yes
<u>BURST COUNT</u> Burst cycle inquiry	?BST	NR1 format: 5 digits Example: BST 00016 (16 cycles)	Yes
<u>START/STOP PHASE</u> Start/stop phase inquiry (degrees)	?SPH	NR2 format: 4-digit mantissa Example: SPH -180.0 (-180°)	Yes

Table 4-13. Model 3930A Sweep Parameter Inquiry Messages

Inquiry Description	Program Code	Response Format	Setting
<u>SWEEP START FREQUENCY</u> Sweep start frequency inquiry (Freq: Hz)	?STF	NR3 format: 11-digit mantissa, 2-digit exponent Example: STF 0100.0000000E+03 (100kHz)	Yes
<u>SWEEP STOP FREQUENCY</u> Sweep stop frequency inquiry (Freq: Hz)	?SPF	NR3 format: 11-digit mantissa, 2-digit exponent Example: SPF 1000.0000000E+03 (1MHz)	Yes
<u>SWEEP CENTER FREQUENCY</u> Sweep center frequency inquiry (Freq: Hz)	?CTF	NR3 format: 11-digit mantissa, 2-digit exponent Example: CTF 0100.0000000E+03 (100kHz)	Yes
<u>SWEEP SPAN FREQUENCY</u> Sweep span frequency inquiry (Freq: Hz)	?SNF	NR3 format: 11-digit mantissa, 2-digit exponent Example: SPF 1000.0000000E+03 (1MHz)	Yes
<u>SWEEP MARKER FREQUENCY</u> Sweep marker frequency inquiry (Freq: Hz)	?MKF	NR3 format: 11-digit mantissa, 2-digit exponent Example: MKF 0100.0000000E+03 (100kHz)	Yes
<u>SWEEP START PERIOD</u> Inquiry as to period of sweep start fre- quency (Period: s)	?STD	NR3 format: 6-digit mantissa, 2-digit exponent Example: STD 3.33333E-03 (3.33333ms = 300Hz)	Yes
<u>SWEEP STOP PERIOD</u> Inquiry as to period of sweep stop fre- quency (Period: s)	?SPD	NR3 format: 6-digit mantissa, 2-digit exponent Example: SPD 3.33333E-03 (3.33333ms = 300Hz)	Yes
<u>SWEEP CENTER PERIOD</u> Inquiry as to period of sweep center fre- quency (Period: s)	?CTD	NR3 format: 6-digit mantissa, 2-digit exponent Example: CTD 3.33333E-03 (3.33333ms=300Hz)	Yes
<u>SWEEP SPAN PERIOD</u> Inquiry as to period of sweep span fre- quency (Period: s)	?SND	NR3 format: 6-digit mantissa, 2-digit exponent Example: SND 3.33333E-03 (3.33333ms = 300Hz)	Yes
<u>SWEEP MARKER PERIOD</u> Inquiry as to period of sweep marker fre- quency (Period: s)	?MKD	NR3 format: 6-digit mantissa 2-digit exponent Example: MKD 3.33333E-03 (3.33333ms=300Hz)	Yes
<u>SWEEP TIME</u> Sweep time inquiry (s)	?STM	NR3 format: 4-digit mantissa 2-digit exponent Example: STM 1.234E+00 (1.234s)	Yes

Model 3930A Sweep Parameter Inquiry Messages (Cont.)

Inquiry Description	Program Code	Response Format	Setting
<u>S</u> WEEP <u>F</u> UNCTION Sweep function inquiry	?SFN	NR1 format: 1 digit, same as setting value. Example: SFN 1	Yes
<u>S</u> INGL <u>S</u> TART IN BNC <u>E</u> NABLE Inquiry as to whether or not rear panel SINGL START IN connector is enabled in remote.	?SGE	NR1 format: 1 digit, same as setting value. Example: SGE 1 (enabled)	Yes
<u>H</u> OLD IN BNC <u>E</u> NABLE Inquiry as to whether or not rear panel SWEEP HOLD IN connector is enabled while in remote.	?HLE	NR1 format: 1 digit, same as setting value. Example: HLE 0 (Disabled)	Yes

Table 4-14. Model 3930A Miscellaneous Parameter Inquiry Messages

Inquiry Description	Program Code	Response Format	Setting
<u>A</u> MPLITUDE <u>M</u> ODULATION AM on/off inquiry	?AMM	NR1 format: 1 digit, same as setting value. Example: AMM 1 (on)	Yes
<u>D</u> UTY <u>C</u> YCLE Square wave duty cycle inquiry (%)	?DTY	NR2 format: 2-digit mantissa Example: DTY 25.0 (25%) NOTE: If the duty cycle is 50% fixed, or if the duty cycle is 50% variable, the response is DTY 50.0.	Yes
<u>F</u> UNCTION <u>O</u> UTPUT <u>O</u> N/ <u>O</u> FF Waveform output on/off inquiry	?FNO	NR1 format: 1 digit, same as setting value. Example: FNO 1 (on)	Yes
<u>O</u> UTPUT <u>R</u> ANGE <u>M</u> ODE Output range mode inquiry	?OMD	NR1 format: 1 digit, same as setting value. Example: OMD 0 (AUTO)	Yes

Table 4-15. Inquiry Messages for Parameters Specific to Model 3930A GPIB

Inquiry Description	Program Code	Response Format	Setting
<u>HEADER ON/OFF</u> Inquiry: Header in inquiry response on or off	?HDR	NR1 format: 1 digit, same as setting value. Example: HDR 1 (on) HDR 0 (off)	Yes
<u>SRQ MASK</u> SRQ mask setting inquiry (Refer to paragraph 4.2.2, Service Requests)	?MSK	NR1 format: 2 digits. For details refer to SRQ setting program code. Example: MSK 32 (No SRQ on error only)	Yes
<u>STATUS BYTE</u> Status byte request (Refer to paragraph 4.2.2, Status Byte)	?STS	NR1 format: 3 digits. Output 8-bit status byte as base-10 number string. Example: STS 122 (122 = 0111 1010)	No
<u>ERROR STATUS</u> Rear error number (Refer to paragraph 4.2.2, Error Codes)	?ERR	NR1 format: 2 digits. Output number of error that occurred most recently. If error has been cleared and the error number is read, -01 is sent. Example: ERR 00 (GPIB error)	No
<u>UNIT IDENTIFICATION</u> Device type/name inquiry	?IDT	NR1 format: 4 digits Example: IDT 3930	No

4.4 MODEL 3933A PHASE SHIFTER PROGRAM CODES

Model 3933A, refer to the Model 3933A Instruction Manual.

Program codes for the optional Model 3933A Phase Shifter are summarized in Table 4-16 through Table 4-23 for your convenience. For detailed information on using the

4.4.1 Model 3933A Phase Shifter Parameter Setting Messages

Table 4-16. Model 3933A Phase Shifter Main Parameter Setting Range

Function	Program Code		Operation and Setting Range	Inquiry
	Header	Parameter		
<u>PHASE</u>	PHS	NR2	Phase difference between main signal from Model 3930A and phase shifter output (°: deg). Range: -360.0 to 360.0 (-360.0° to 360.0°) Resolution: 0.1° Example: PHS 180.0 (180.0°)	Yes
<u>AMPLITUDE (V_{p-p})</u>	AMV	NR3	Sets output amplitude (V _{p-p}) Range: In AUTO output range mode: 0.3E-03 (0.3mV _{p-p}) to 30.0E+00 (30V _{p-p}) In FXD output range mode: 0.00E+00 (0V _{p-p}) to 30.00E+00 (30V _{p-p}) Resolution: AUTO output range: 0.01mV _{p-p} FXD output range: 10mV _{p-p} Example: AMV 2.0E+00 (2V _{p-p})	Yes
<u>AMPLITUDE (V_{rms})</u> (AUTO output range mode only)	AMR	NR3	Sets output amplitude (V _{rms}) Range: For sine wave: 0.11E-03 (0.11mV _{rms}) to 10.6E+00 (10.6V _{rms}) For sawtooth or triangular: 0.09E-03 (0.09mV _{rms}) to 8.66E+00 (8.66V _{rms}) For square wave: 0.15E-03 (0.15mV _{rms}) to 15.0E+00 (15.0V _{rms}) Resolution: 0.01mV _{rms} Example: AMR 7.1E+0 (7.1V _{rms})	Yes

Model 3933A Phase Shifter Main Parameter Setting Range (Cont.)











Function	Program Code		Operation and Setting Range	Inquiry
	Header	Parameter		
<u>AMPLITUDE</u> (dBV) (AUTO output range mode only)	AMD	NR3	Sets output amplitude (dBV) Range: For sine wave: -79.2E+00 (-79.2dBV) to 20.5E+00 (20.5dBV) For sawtooth or triangular: -80.9E+00 (-80.9dBV) to 18.8E+00 (18.8dBV) For square wave: -76.5E+00 (-76.5dBV) to 23.5E+00 (23.5dBV) Resolution: 0.1dBV Example: AMD -10.5E+0 (-10.5dBV)	Yes
<u>OFFSET</u>	OFS	NR3	Sets DC offset voltage (V) Range: In AUTO output range: -15.0E+00 (-15V) to 15.0E+00 (15V) In FXD output range: -15.0E+00 (-15V) to 15.0E+00 (15V) Resolution: AUTO output range: 0.01mV FXD output range: 10mV Example: OFS 4.56E-1 (0.456V)	Yes
<u>FUNCTION</u>	FNC	NR1	Selects output waveform Range: 0 to 5 0: DC 1:  2:  3:  4:  5:  Example: FNC 1 ()	Yes

Table 4-17. Model 3933A Phase Shifter Sweep Parameter Setting Messages

Function	Program Code		Operation and Setting Range	Inquiry
	Header	Parameter		
SWEEP <u>S</u> TART <u>P</u> HASE	STP	NR2	Sets sweep start phase (°: deg) Range: 360.0 to -360.0 (360.0° to -360.0°) Resolution: 0.1° Example: STP 180.0 (180.0°)	Yes
SWEEP <u>S</u> TOP <u>P</u> HASE	SPP	NR2	Sets sweep stop phase (°: deg) Range: 360.0 to -360.0 (360.0° to -360.0°) Resolution: 0.1° Example: SPP 180.0 (180.0°)	Yes
SWEEP <u>C</u> ENTER <u>P</u> HASE	CTP	NR2	Sets sweep center phase (°: deg) Range: 360.0 to -360.0 (360.0° to -360.0°) Resolution: 0.1° Example: CTP 180.0 (180.0°)	Yes
SWEEP <u>S</u> PAN <u>P</u> HASE	SNP	NR2	Sets sweep span phase (°: deg) Range: 000.0 to -720.0 (000.0° to 720.0°) Resolution: 0.1° Example: SNP 180.0 (180.0°)	Yes
SWEEP <u>M</u> ARKER <u>P</u> HASE	MKP	NR2	Sets sweep marker phase (°: deg) Range: 360.0 to -360.0 (360.0° to -360.0°) Resolution: 0.1° Example: MKP 180.0 (180.0°)	Yes
<u>C</u> ENTER <u>F</u> ROM <u>M</u> ARKER	CFM	None	Assigns marker phase to center phase	No
<u>S</u> WEEP <u>T</u> IME	STM	NR3	Sets sweep time (s) Range: 5.0E-03 (5ms) to 9.999E+03 (9999s) Resolution: 1ms Example: STM 1.0E+00 (1s)	Yes
<u>S</u> WEEP <u>F</u> UNCTION	SFN	NR1	Select sweep function Range: 0 to 2 0:  1:  2:  Example: SFN 2 ()	Yes
<u>S</u> WEEP <u>O</u> FF	SOF	None	Disables sweep	No
<u>S</u> WEEP <u>C</u> ONTINUOUS <u>S</u> TART	SCN	None	Starts continuous sweep	No

Model 3933A Phase Shifter Sweep Parameter Setting Messages (Cont.)

Function	Program Code		Operation and Setting Range	Inquiry
	Header	Parameter		
<u>S</u> WEEP <u>S</u> INGLE <u>S</u> TART	SSG	None	Starts single sweep	No
<u>S</u> INGL <u>S</u> TART <u>B</u> NC <u>E</u> NABLE	SGE	NR1	Enables/disables rear panel SINGL START IN BNC connector when unit is in remote. (SGE1: when SINGL START IN is enabled, and START signal is received, a single sweep is performed. In local this connector is always enabled. When unit is placed in remote, status of SINGL START IN returns to setting when previously in remote. Range: 0 or 1 0: Disables SINGL START IN while unit is in remote. 1: Enables SINGL START IN while unit is in remote. Example: SGE 1	Yes
<u>S</u> WEEP <u>S</u> TART <u>S</u> TATE	SST	None	Outputs start phase. (If this code is given during a sweep, the sweep halts, and the start phase is output.)	No
<u>S</u> WEEP <u>S</u> TOP <u>S</u> TATE	SSP	None	Outputs stop phase. (If this code is given during a sweep, the sweep halts, and the stop phase is output.)	No
<u>S</u> WEEP <u>H</u> OLD	HLD	None	Temporarily halts sweep.	No
<u>S</u> WEEP <u>R</u> ESUME	RSM	None	Restarts sweep (If RSM is sent with the sweep not in HOLD, the command is ignored, and no error occurs.)	No
<u>H</u> OLD <u>I</u> N <u>B</u> NC <u>E</u> NABLE	HLE	NR1	Enables/disables rear panel HOLD IN connector when unit is in remote. (In local, HOLD IN is always enabled. When the unit returns to the remote state, HOLD IN assumes the previous remote status. Initial status at power up or when the PST code has been executed is HLE 1.) Range: 0 or 1 0: Disables HOLD IN when unit is in remote. 1: Enables HOLD IN when unit is in remote. Example: HLE 0 (Disabled in remote)	Yes

NOTE: When HOLD IN is enabled (HLE 1), the relationship between the HOLD IN connector and the HLD and RSM codes is as follows:

1. When a HOLD signal is applied to HOLD IN (set low), the HLD and RSM codes have no effect on the sweep. The sweep restarts when HOLD is removed from the HOLD IN connector (set high).
2. When a sweep has been halted by the HLD code, the HOLD IN connector is disabled. The sweep resumes when a RSM command is issued.

Table 4-18. Model 3933A Phase Shifter Miscellaneous Parameter Setting Messages

Function	Program Code		Operation and Setting Range	Inquiry
	Header	Parameter		
<u>A</u> MPLITUDE <u>M</u> ODULATION ON/OFF	AMM	NR1	AM on/off Range: 0 or 1 0: Off 1: On Example: AMM 0	Yes
<u>D</u> UTY CYCLE	DTY	NR2	Sets square wave duty cycle (%) Range: 5.0 to 95.0 (5.0% to 95.0%) Resolution: 0.1% Example: DTY 12.5 (12.5%)	Yes
<u>D</u> UTY CYCLE <u>F</u> IXED	DYF	None	Sets square wave duty cycle to 50% fixed. Example: DYF	No
<u>M</u> EMORY <u>S</u> TORE	STO	NR1	Stores setting conditions in memory. Range: 0 to 9 (memory number) Example: STO 1	No
<u>M</u> EMORY <u>R</u> ECALL	RCL	NR1	Recalls setting conditions from memory Range: 0 to 9 (memory number) Example: RCL 9	No
<u>D</u> ISPLAY	DSP	None	Displays main parameters Example: DSP	No
<u>P</u> RESET	PST	None	Sets unit to preset settings Example: PST	No
<u>F</u> UNCTION <u>O</u> UTPUT ON/OFF	FNO	NR1	Turns waveform output on/off Range: 0 or 1 0: Off 1: On Example: FNO 1	Yes
<u>O</u> UTPUT RANGE <u>M</u> ODE	OMD	NR1	Selects output range mode Range: 0 or 1 0: Automatic (AUTO) 1: Fixed (FXD)	Yes

Table 4-19. Parameter Setting Messages Specific to Model 3933A Phase Shifter GPIB

Function	Program Code		Operation and Setting Range	Inquiry
	Header	Parameter		
<u>HEADER ON/OFF</u>	HDR	NR1	<p>Enables/disables inquiry response message header.</p> <p>Range: 0 or 1</p> <p>0: No header in inquiry response (off).</p> <p>1: Include header in inquiry response (on).</p> <p>Example: HDR 1 (Header on)</p>	Yes
<u>SRQ MASK</u>	MSK	NR1	<p>Sets SRQ mask.</p> <p>Range: 00 to 63</p> <p>32: Error occurred.</p> <p>32: No SRQ sent when error occurs.</p> <p>0: Send SRQ when error occurs.</p> <p>16: No effect (same as 0)</p> <p>8: No effect (same as 0)</p> <p>4: SWEEP stop</p> <p>4: No SRQ sent when SWEEP stops</p> <p>0: Send SRQ when SWEEP stops</p> <p>2: SWEEP start</p> <p>2: No SRQ sent when SWEEP starts</p> <p>0: Send SRQ when SWEEP starts</p> <p>1: Output ready with inquiry response message</p> <p>1: No output ready SRQ</p> <p>0: Send SRQ when output ready with response.</p> <p>Add up mask values for multiple SRQ conditions.</p> <p>Example: MSK 6 (6 = 4 + 2: No SRQ sent at SWEEP stop or start. SRQ sent at error generation and output ready)</p>	Yes

4.4.2 Model 3933A Phase Shifter Inquiry Messages

is off (HDR 0), the header is not send, and only the parameter is returned. The parameter begins with a space or minus sign (-).

The examples shown in Table 4-20 through Table 4-23 are for when the header is on (HDR 1). When the header

Table 4-20. Model 3933A Phase Shifter Main Parameter Inquiry Messages

Inquiry Description	Program Code	Response Format	Setting
<u>PHASE</u> Inquiry of phase difference between main Model 3930A signal and Model 3933A output signal (°: deg)	?PHS	NR2 format: 6-digit mantissa Example: PHS -180.0 (-180.0°)	Yes
<u>AMPLITUDE (V_{p-p})</u> Output amplitude inquiry (V _{p-p})	?AMV	NR3 format: In AUTO output range mode: 3-digit mantissa, 2-digit exponent In FXD output range mode: 4-digit mantissa, 2-digit exponent Example: AMV 10.0E+00 (10V _{p-p})	Yes
<u>AMPLITUDE (V_{rms})</u> Output amplitude inquiry (V _{rms}) (AUTO output range mode only)	?AMR	NR3 format: 3-digit mantissa 2-digit exponent Example: AMR 1.23E+00 (1.23V _{rms})	Yes
<u>AMPLITUDE (dBV)</u> Output amplitude inquiry (dBV) (AUTO output range mode only)	?AMD	NR3 format: 3-digit mantissa 2-digit exponent Example: AMD 01.0E+00 (1dBV)	Yes
<u>OFFSET</u> DC offset voltage inquiry	?OFS	NR3 format: In AUTO output range mode: 3-digit mantissa, 2-digit exponent In FXD output range mode: 4-digit mantissa, 2-digit exponent Example: OFS -12.3E+00 (-12.3V)	Yes
<u>FUNCTION</u> Output waveform inquiry	?FNC	NR1 format: 1 digit, same as setting value. Example: FNC 1 (sine wave)	Yes

Table 4-21. Model 3933A Phase Shifter Sweep Parameter Inquiry Messages

Inquiry Description	Program Code	Response Format	Setting
<u>S</u> WEEP <u>S</u> TART <u>P</u> HASE Sweep start phase inquiry (°: deg)	?STP	NR2 format: 4-digit mantissa Example: STP -120.0 (-120.0°)	Yes
<u>S</u> WEEP <u>S</u> TOP <u>P</u> HASE Sweep stop phase inquiry (°: deg)	?SPP	NR2 format: 4-digit mantissa Example: SPP -120.0 (-120°)	Yes
<u>S</u> WEEP <u>C</u> ENTER <u>P</u> HASE Sweep center phase inquiry (°: deg)	?CTP	NR2 format: 4-digit mantissa Example: CTP 000.0 (0°)	Yes
<u>S</u> WEEP <u>S</u> PAN <u>P</u> HASE Sweep phase span inquiry (°: deg)	?SNP	NR2 format: 4-digit mantissa Example: SNP 240.0 (240°)	Yes
<u>S</u> WEEP <u>M</u> ARKER <u>P</u> HASE Sweep marker phase inquiry (°: deg)	?MKP	NR2 format: 4-digit mantissa Example: MKP 090.0 (90°)	Yes
<u>S</u> WEEP <u>T</u> IME Sweep time inquiry (s)	?STM	NR3 format: 4-digit mantissa, 2-digit exponent Example: STM 1.234E+00 (1.234s)	Yes
<u>S</u> WEEP <u>F</u> UNCTION Sweep function inquiry	?SFN	NR1 format: 1 digit, same as setting value Example: SFN 1	Yes
<u>S</u> INGL <u>S</u> TART <u>I</u> N <u>B</u> NC <u>E</u> NABLE Inquiry as to whether or not rear panel SINGL START IN BNC connector is en- abled in remote	?SGE	NR1 format: 1 digit, same as setting value Example: SGE 1 (enabled)	Yes
<u>H</u> OLD <u>I</u> N <u>B</u> NC <u>E</u> NABLE Inquiry as to whether or not rear panel HOLD IN connector is enabled in remote	?HLE	NR1 format: 1 digit, same as setting value. Example: HLE 0 (disabled)	Yes

Table 4-22. Model 3933A Phase Shifter Miscellaneous Parameter Inquiry Messages

Inquiry Description	Program Code	Response Format	Setting
<u>A</u> MPLITUDE <u>M</u> ODULATION AM on/off inquiry	?AMM	NR2 format: 1 digit, same a setting value Example: AMM 1 (on)	Yes
<u>D</u> UTY <u>C</u> YCLE Square wave duty cycle inquiry (%)	?DTY	NR2 format: 2-digit mantissa Example: DTY 25.0 (25%) NOTE: The response is DTY 50.0 for both 50% fixed and 50% variable duty cycle.	Yes
<u>F</u> UNCTION <u>O</u> UTPUT <u>O</u> N/ <u>O</u> FF Waveform output on/off inquiry	?FNO	NR1 format: 1 digit, same as setting value Example: FNO 1 (on)	Yes
<u>O</u> UTPUT <u>R</u> ANGE <u>M</u> ODE Output range mode inquiry	?OMD	NR1 format: 1 digit, same as setting value Example: OMD 0 (AUTO)	Yes

Table 4-23. Inquiry Messages for Parameters Specific to Model 3933A Phase Shifter GPIB

Inquiry Description	Program Code	Response Format	Setting
<u>HEADER ON/OFF</u> Inquiry as to whether inquiry response message header is on or off	?HDR	NR1 format: 1 digit, same as setting value. Example: HDR 1 (on) HDR 0 (off)	Yes
<u>SRQ MASK</u> SRQ mask setting inquiry	?MSK	NR1 format: 2 digits. For details refer to parameter setting code Example: MSK 07 (SRQ at error generation only)	Yes
<u>STATUS BYTE</u> Status byte	?STS	NR1 format: 3 digits. Output 8-bit status byte as base-10 number string. Example: STS 122 (122 = 0111 1010)	No
<u>ERROR STATUS</u>	?ERR	NR1 format: 2 digits. Output number of error that occurred most recently. If error has been cleared and the error number is read, -01 is output. Example: ERR 00 (GPIB error)	No
<u>IDENTIFICATION</u> Device type/name inquiry	?IDT	NR1 format: 4 digits Example: IDT 3933	No

4.5 TYPICAL EXECUTION TIMES

The execution times shown in Table 4-24 are the times required from the reception of the command until execution is complete. For inquiry messages, the execution time is the time required from reception of the command to the time when the output returns to the ready state. These execution times are applicable only when a sweep is not in progress. During a sweep, execution times may increase by a factor of from several to one hundred times, depending on the sweep condition.

It takes about 1msec/byte for the Model 3930A to receive a command from the GPIB. The execution times given in the table are those for which the number of message characters is the same as the number of characters returned by the corresponding inquiry.

It takes about 1.5msec/byte for the Model 3930A to transfer data in the talker mode.

Table 4-24. Typical Execution Times

Function	Setting Message Header	Typical Execution Time (ms)	Inquiry Message	Typical Execution Time (ms)
Oscillation Frequency (Freq: Hz)	FRQ	40	?FRQ	29
Oscillation Frequency (Period: s)	PRD	48	?PRD	29
Phase Difference with Main Signal (degrees)	PHS	22	?PHS	20
Output Amplitude (Vp-p)	AMV	36	?AMV	18
Output Amplitude (Vrms)	AMR	34	?AMR	27
Output Amplitude (dBV)	AMD	38	?AMD	32
DC Offset Voltage (V)	OFS	38	?OFS	19
Output Waveform	FNC	10	?FNC	15
Oscillation Mode	MOD	12	?MOD	17
Trigger Source	TRS	19	?TRS	24
Remote Trigger	TRG	18	?TRG	20
EXT TRIG IN Connector Enabled/Disabled in Remote	TRE	18	?TRE	20
Internal Trigger Oscillation Period (Period: s)	TRR	46	?TRR	28
Internal Trigger Oscillation Frequency (Freq: Hz)	TRF	49	?TRF	40
Burst Cycles	BST	16	?BST	16

Typical Execution Times (Cont.)

Function	Setting Message Header	Typical Execution Time (ms)	Inquiry Message	Typical Execution Time (ms)
Start/stop Phase	SPH	25	?SPH	22
Sweep Start Frequency	STF	56	?STF	36
Sweep Stop Frequency	SPF	55	?SPF	35
Sweep Center Frequency	CTF	54	?CTF	28
Sweep Span Frequency	SNF	60	?SNF	34
Sweep Marker Frequency	MKF	41	?MKF	31
Sweep Start Frequency	STD	66	?STD	32
Sweep Stop Frequency	SPD	71	?SPD	31
Sweep Center Frequency	CTD	73	?CTD	36
Sweep Span Period	SND	79	?SND	42
Sweep Marker Period	MKD	46	?MKD	28
Sweep Start Phase	STP	36	?STP	27
Sweep Stop Phase	SPP	34	?SPP	25
Sweep Center Phase	CTP	32	?CTP	16
Sweep Phase Width	SNP	41	?SNP	26
Sweep Marker Phase	MKP	20	?MKP	19
Marker to Center Frequency	CFM	56	—	—
Marker to Center Phase	CFM	23	—	—
Sweep Time	STM	40	?STM	25
Sweep Function	SFN	14	?SFN	19
Sweep Off	SOF	12 (NOTE 1)	—	—
Start Continuous Sweep	SCN	NOTE 2		
Start Single Sweep	SSG	NOTE 2		
SINGL START IN Connector Enabled/Disabled in Remote	SGE	14	?SGE	16

Typical Execution Times (Cont.)

Function	Setting Message Header	Typical Execution Time (ms)	Inquiry Message	Typical Execution Time (ms)
Sweep Start State	SST	18	—	—
Sweep Stop State	SSP	18	—	—
Sweep Temp. Hold	HLD	8 (NOTE 1)	—	—
Sweep Resume	RSM	11 (NOTE 1)	—	—
HOLD IN Connector Enabled/ disabled in Remote	HLE	11	?HLE	12
AM On/Off	AMM	8	?AMM	13
Duty Cycle (%)	DTY	23	?DTY	15
Duty Cycle Fixed 50%	DYF	8	—	—
Store Settings	STO	39	—	—
Recall Settings	RCL	57	—	—
Main Parameter Display	DSP	27	—	—
Preset	PST	53	—	—
Waveform Output On/Off	FNO	19	?FNO	21
Header On/Off	HDR	10	?HDR	12
SRQ Mask	MSK	13	?MSK	14
Status Byte Inquiry	—	—	?STS	20
Error Status Inquiry	---	—	?ERR	12
Machine Type/Name Inq.	—	—	?IDT	14

NOTE 1: All times in the tables are non-sweep times. Execution time varies depending on sweep conditions. For example, during a sweep (when settings are preset and the unit is sweeping continuously):
 Model 3930A "HOLD" and "SOF" execution times are about 83ms and 123ms.
 Model 3933A "HOLD" and "SOF" execution times are about 32ms and 29ms.
 "RSM" execution time during Model 3930A HOLD is about 15 ms.









NOTE 2: Execution times vary greatly with sweep conditions because of sweep calculation times. Sweep calculations take a maximum of about 400 ms.

4.6 PROGRAM CODE SUMMARY TABLES

Table 4-25 shows the summary of the Model 3930A program codes, and Table 4-26 summarizes program codes for the optional Model 3933A Phase Shifter.

In these tables, the number of digits for response messages are expressed in the form of (number of digits for mantissa) + (number of digits for exponent). The number of digits for the exponent is always 2.

Table 4-25. Model 3930A Program Code Summary

Function	Setting and Response Messages		Inquiry Message	Response Digits
	Header	Parameter		
Oscillation Frequency (Frequency: Hz)	FRQ	NR3	?FRQ	11 + 2
Oscillation Frequency (Period: s)	PRD	NR3	?PRD	6 + 2
Output Amplitude (Vp-p)	AMV	NR3	?AMV	AUTO: 3 + 2 FIXED: 4 + 2
Output Amplitude (Vrms)	AMR	NR3	?AMR	3 + 2
Output Amplitude (dBV)	AMD	NR3	?AMD	3 + 2
DC Offset Voltage (V)	OFS	NR3	?OFS	AUTO: 3 + 2 FIXED: 4 + 2
Output Waveform: 0: DC 3:  1:  4:  2:  5: 	FNC	NR1	?FNC	1
Oscillation Mode 0: CONT 1: BRST 2: GATE	MOD	NR1	?MOD	1
Trigger Source 0: EXT  2: INT  1: EXT  3: INT 	TRS	NR1	?TRS	1
Remote Trigger 0: Trigger Inactive 1: Trigger Active	TRG	NR1	?TRG	1
EXT TRIG IN Connector Disabled/ enabled in Remote 0: Invalid 1: Valid	TRE	NR1	?TRE	1
Internal Trigger Oscillation Period (Period: s)	TRR	NR3	?TRR	5 + 2
Internal Trigger Oscillation Period (Freq: Hz)	TRF	NR3	?TRF	5 + 2

Model 3930A Program Code Summary (Cont.)









Function	Setting and Response Messages		Inquiry Message	Response Digits
	Header	Parameter		
Burst Cycles (cycle)	BST	NR1	?BST	5
Start/Stop Phase (deg.)	SPH	NR2	?SPH	4
Sweep Start Freq. (Hz)	STF	NR3	?STF	11 + 2
Sweep Stop Freq. (Hz)	SPF	NR3	?SPF	11 + 2
Sweep Center Freq. (Hz)	CTF	NR3	?CTF	11 + 2
Sweep Freq. Span (Hz)	SNF	NR3	?SNF	11 + 2
Sweep Marker Freq. (Hz)	MKF	NR3	?MKF	11 + 2
Sweep Start Frequency (Period: s)	STD	NR3	?STD	6 + 2
Sweep Stop Frequency (Period: s)	SPD	NR3	?SPD	6 + 2
Sweep Center Frequency (Period: s)	CTD	NR3	?CTD	6 + 2
Sweep Frequency Span (Period: s)	SND	NR3	?SND	6 + 2
Sweep Marker Frequency (Period: s)	MKD	NR3	?MKD	6 + 2
Marker to Center Frequency	CFM	—	—	—
Sweep Time (s)	STM	NR3	?STM	4 + 2
Sweep Function	SFN	NR1	?SFN	1
Sweep Off	SOF	—	—	—
Start Continuous Sweep	SCN	—	—	—
Start Single Sweep	SSG	—	—	—
SINGLE START IN Connector Enabled/disabled in Remote 0: Disabled 1: Enabled	SGE	NR1	?SGE	1
Sweep Start State	SST	—	—	—
Sweep Stop State	SSP	—	—	—

Model 3930A Program Code Summary (Cont.)

Function	Setting and Response Messages		Inquiry Message	Response Digits
	Header	Parameter		
Sweep Hold	HLD	—	—	—
Sweep Resume	RSM	—	—	—
HOLD IN Connector Enabled/ disabled in Remote 0: Disabled 1: Enabled	HLE	NR1	?HLE	1
AM On/Off 0: Off 1: On	AMM	NR1	?AMM	1
Duty Cycle (%)	DTY	NR2	?DTY	3
Duty Cycle Fixed 50%	DYF	—	—	—
Store Settings	STO	NR1	—	—
Recall Settings	RCL	NR1	—	—
Main Parameter Display	DSP	—	—	—
Preset Settings	PST	—	—	—
Waveform Output On/Off	FNO	NR1	?FNO	1
Output Range Mode	OMD	NR1	?OMD	1
Header On/Off 0: Off 1: On	HDR	NR1	?HDR	1
SRQ Mask	MSK	NR1	?MSK	2
Status Byte Inquiry	(STS)	(NR1)	?STS	3
Error Status Inquiry	(ERR)	(NR1)	?ERR	2
Unit Type/Name Inquiry	(IDT)	(NR1)	?IDT	4

NOTE () = Inquiry message only.

Table 4-26. Model 3933A Phase Shifter Program Code Summary

Function	Setting and Response Messages		Inquiry Message	Response Digits
	Header	Parameter		
Phase Difference with Main Signal from Model 3930A (degrees)	PHS	NR2	?PHS	4
Output Amplitude (Vp-p)	AMV	NR3	?AMV	AUTO: 3 + 2 FIXED: 4 + 2
Output Amplitude (Vrms)	AMR	NR3	?AMR	3 + 2
Output Amplitude (dBV)	AMD	NR3	?AMD	3 + 2
DC Offset Voltage (V)	OFS	NR3	?OFS	AUTO: 3 + 2 FIXED: 4 + 2
Output Waveform: 0: DC 3:  1:  4:  2:  5: 	FNC	NR1	?FNC	1
Sweep Start Phase (deg)	STP	NR3	?STP	4
Sweep Stop Phase (deg)	SPP	NR3	?SPP	4
Sweep Center Phase (deg)	CTP	NR3	?CTP	4
Sweep Phase Span (deg)	SNP	NR3	?SNP	4
Sweep Marker Phase (deg)	MKP	NR3	?MKP	4
Marker to Center Phase	CFM	—	—	—
Sweep Time (s)	STM	NR3	?STM	4 + 2
Sweep Function 0:  1:  2: 	SFN	NR1	?SFN	1
Sweep Off	SOF	—	—	—
Start Continuous Sweep	SCN	—	—	—
Start Single Sweep	SSG	—	—	—
SINGL START IN Connector Enabled/disabled in Remote 0: Disabled 1: Enabled	SGE	NR1	?SGE	1
Sweep Start State	SST	—	—	—
Sweep Stop State	SSP	—	—	—

Model 3933A Phase Shifter Program Code Summary (Cont.)

Function	Setting and Response Messages		Inquiry Message	Response Digits
	Header	Parameter		
Sweep Hold	HLD	---	---	---
Sweep Restart	RSM	---	---	---
HOLD IN Connector Enabled/ disabled in Remote 0: Disabled 1: Enabled	HLE	NR1	?HLE	1
AM On/Off 0: Off 1: On	AMM	NR1	?AMM	1
Duty Cycle (%)	DTY	NR2	?DTY	3
Duty Cycle Fixed 50%	DYF	---	---	---
Store Settings	STO	NR1	---	---
Recall Settings	RCL	NR1	---	---
Main Parameter Display	DSP	---	---	---
Preset Settings	PST	---	---	---
Waveform Output On/Off	FNO	NR1	?FNO	1
Output Range Mode	OMD	NR1	?OMD	1
Header On/Off 0: Off 1: On	HDR	NR1	?HDR	1
SRQ Mask	MSK	NR1	?MSK	2
Status Byte Inquiry	(STS)	(NR1)	?STS	3
Error Status Inquiry	(ERR)	(NR1)	?ERR	2
Unit Type/Name	(IDT)	(NR1)	?IDT	4

NOTE () = Inquiry only.

4.7 SAMPLE PROGRAMS

This paragraph presents two sample programs to control the Model 3930A using an HP 9816 (or equivalent) personal computer as the controller. The primary address of the Model 3930A GPIB interface is assumed to be 2, and the delimiter is <CR><LF>.

Sample program 1 allows you to type in program codes and send them to the Model 3930A. When the program code begins with a "?", the Model 3930A is addressed to talk after the program code is transferred. The response is then read by the controller and displayed on the CRT. When an error occurs, a serial poll is performed, the error code is read, and an error message is displayed on the CRT.

Sample program 2 includes subroutines for sending interface messages IFC, DCL, SDC, LLO, and GTL to the Model 3930A and the subroutines to set REN true or false.

Sample Program 1

```

100 PRINTER IS 1
110 DIM C$(80)
120 ON TIMEOUT 7.20 GOSUB 690
130 ABORT 7
140 CLEAR 7
150 REMOTE 702
160 OUTPUT 702;"MSK 31"
170 ON INTR 7 GOTO 280
180 !
190 ENABLE INTR 7;2
200 INPUT "INPUT PROGRAM CODE".C$
210 PRINT
220 PRINT "COMMAND = ".C$
230 OUTPUT 702:C$
240 IF POS(C$,"?") THEN GOSUB 720
250 FOR I=0 TO 500
260 NEXT I
270 GOTO 190
280 !
290 PRINT "** ERROR SERVICE ROUTINE **"

300 S=SPOLL(702)
310 OUTPUT 702;"?ERR"
320 ENTER 702:E$
330 OUTPUT 702;"?HDR"
340 ENTER 702:H$
350 IF H$="HDR 1" THEN
360   E=VAL(E$(4,6))
370 ELSE
380   E=VAL(E$)
390 END IF
400 SELECT E
410   CASE 0
420     PRINT " (ERROR 00) GPIB ERROR !"
430   CASE 1
440     PRINT " (ERROR 01) UNIT ERROR !"
450   CASE 2
460     PRINT " (ERROR 02) FREQ ERROR !"
470   CASE 3
480     PRINT " (ERROR 03) PHAS ERROR !"
490   CASE 4
500     PRINT " (ERROR 04) AMPT ERROR !"
510   CASE 5
520     PRINT " (ERROR 05) OFST ERROR !"
530   CASE 6
540     PRINT " (ERROR 06) ACDC ERROR !"
550   CASE 7
560     PRINT " (ERROR 07) FRDT ERROR !"
570   CASE 8
580     PRINT " (ERROR 08) SWP ERROR !"
590   CASE 9
600     PRINT " (ERROR 09) RNGE ERROR !"
610   CASE 10
620     PRINT " (ERROR 10) CNVT ERROR !"
630   CASE 11
640     PRINT " (ERROR 11) MEMO ERROR !"
650   CASE 12
660     PRINT " (ERROR 12) NODT ERROR !"
670 END SELECT
680 GOTO 190
690 !
700 PRINT "** GPIB Hang up **"
710 RETURN
720 !
730 ENTER 702:C$
740 PRINT " ANSWER = ".C$
750 RETURN
760 !
770 END

```

Sample Program 1 Description

Line	Description
100 to 170	Initializes controller and Model 3930A.
100	Specifies CRT display.
110	Defines C\$ variable for 80 characters.
120	Sets interrupt time to 20 seconds.
130	Sends IFC.
140, 150	Sets REN true and sends DCL.
160	Sends MSK 31 to unit to enable SRQ on error.
170	Enables SRQ branching to line 280 on interrupt.
190 to 270	Loop to send program codes to Model 3930A.
190	Enables controller SRQ interrupt.
200, 210	Inputs program code into C\$
220	Displays input program code.
230	Sends program code to Model 3930A.
240	Executes specified subroutine when program code contains "?".
250, 260	Wait loop to ensure SRQ detection.
270	Returns to line 190.
290 to 680	Subroutine for generating SRQ interrupt.
300	Performs serial poll.
310, 320	Reads error code into E\$.
330, 340	Reads information on whether or not inquiry message has header (H\$).
350 to 390	Obtains error number (E).
400 to 670	Display error corresponding to error number E.
700, 710	Subroutine for displaying timeout.
730 to 750	Subroutine for reading and displaying unit settings.

Sample Program 2

```

1000 !
1010 !   *** IFC
1020 ABORT 7
1030 RETURN
1040 !
1050 !   *** DCL
1060 CLEAR 7
1070 RETURN
1080 !
1090 !   *** SDC
1100 CLEAR 702
1110 RETURN
1120 !
1130 !   *** LLO
1140 LOCAL LOCKOUT 7
1150 RETURN
1160 !
1170 !   *** GTL
1180 LOCAL 702
1190 RETURN
1200 !
1210 !   *** REN True
1220 REMOTE 7
1230 RETURN
1240 !
1250 !   *** REN False
1260 LOCAL 7
1270 RETURN
  
```

APPENDIX A

Typical Data

INTRODUCTION

Appendix A provides the typical performance data for the Model 3930A.

This instrument was thoroughly tested and inspected

and certified as meeting its published specifications when it was shipped from the factory. However, the typical data represents mean values of measurements for each Model 3930A. Thus, measured performance of your Model 3930A may be different than that indicated by the typical data curves shown here.

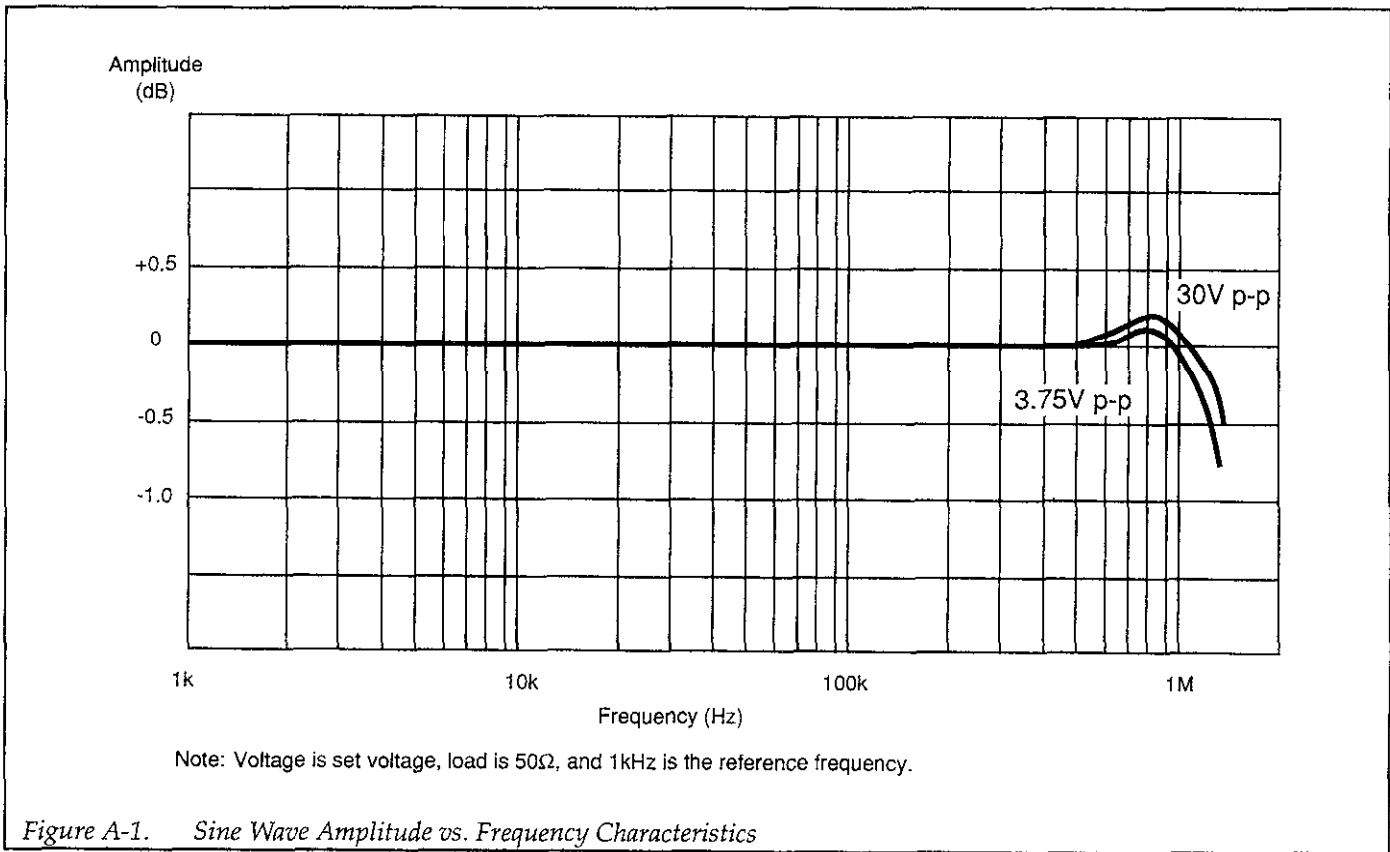

Figure A-1. Sine Wave Amplitude vs. Frequency Characteristics

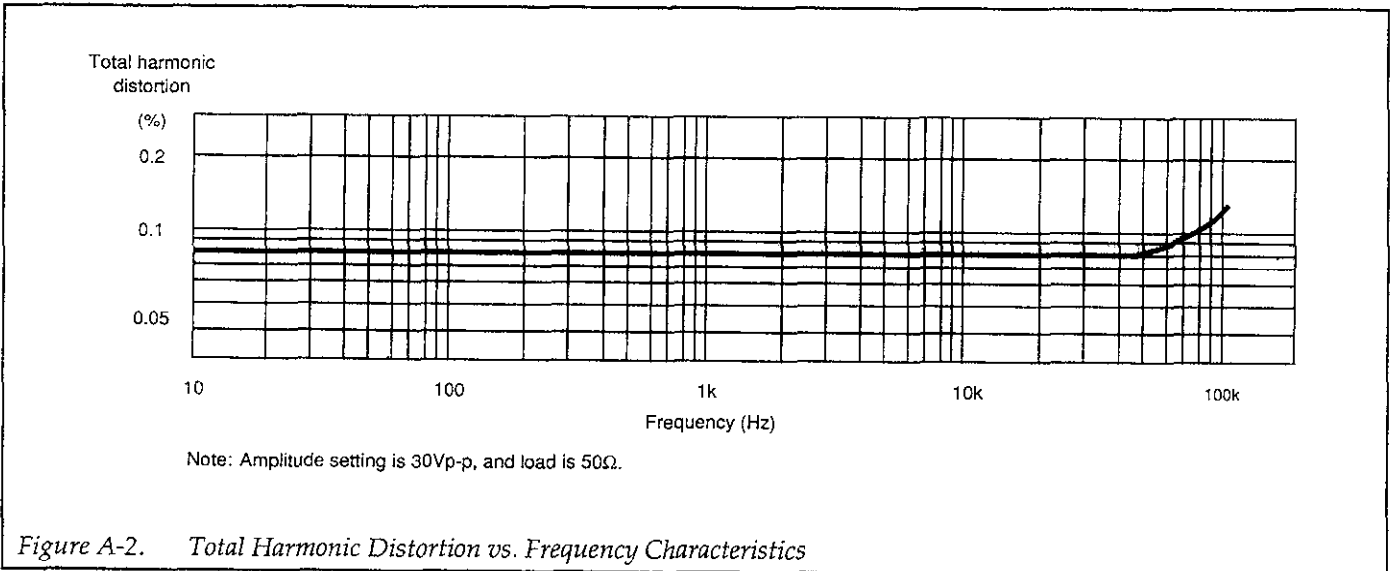

Figure A-2. Total Harmonic Distortion vs. Frequency Characteristics

APPENDIX B

Model 3930A Specifications

B.1 ELECTRICAL SPECIFICATIONS

Waveforms	
Types	DC only, \sim , \square , ∇ , \wedge , \searrow

Oscillation Modes		
Continuous	CONT	Continuous oscillation
Burst	BURST	N-cycles (N is an integer) generated by a trigger signal. N=1 to 65,536
Gate	GATE	N-cycles generated while trigger signal is on (N=integer).

Frequency		
Waveform and Frequency Range	\sim , \square (Duty cycle fixed at 50%)	0.1mHz to 1.2MHz
	∇ , \wedge , \searrow , \square (Duty cycle variable from 5% to 95%)	0.1mHz to 100kHz
Display	Maximum 11 digits, resolution 0.1mHz (fixed)	
Accuracy	$\pm 5 \times 10^{-6}$ (± 5 ppm)	
Stability	$\pm 2 \times 10^{-6}$ / year (± 2 ppm/year)	
Setting by period	Setting range	840ns to 10000s
	Display	Maximum 6 digits, minimum resolution 10ns
	Oscillation frequency is the reciprocal of the setting period (settings below 0.1mHz are truncated)	

Output Characteristics (Waveform Output)					
Maximum Output	AC only		30Vp-p/open, 15Vp-p/50 Ω load		
	DC only		± 15 V/open, ± 7.5 V/50 Ω load		
Display (Open Circuit Value)	When output range mode is automatic (AUTO)				
	AC	Vp-p	Max. 3 digits	Minimum Resolution	0.01mVp-p
		Vrms	Max. 3 places \pm		0.01mVrms
		dBV	display		0.1dBV (fixed)
	DC		Max. 3 digits + neg. display, min. resolution 0.01mV when output range mode is fixed (FXD)		
AC (Vp-p only)		Maximum 4 digits, minimum resolution 10mVp-p (fixed)			
DC		Maximum 4 digits \pm display, minimum resolution 10mV (fixed)			
AC Amplitude Setting Range (at DC offset 0V)	Per Table B-1: AC Amplitude Setting Range for 0V DC offset				

Specifications subject to change without notice.

ELECTRICAL SPECIFICATIONS (CONT.)

Output Characteristics (Waveform Output) (Cont.)					
AC Amplitude Accuracy (in CONT mode)	Up to 50kHz frequency, 0V DC offset, AM off, open load, effective value measurement, 18-28°C				
	~	When output range is AUTO	3.00Vp-p to 30.0Vp-p	±0.5%	
			300mVp-p to 2.99Vp-p	±1.0%	
			30.0mVp-p to 299mVp-p	±1.5%	
	~	When output range is FXD	3.00Vp-p to 30.00Vp-p	±0.5%	
			0.30Vp-p to 2.99Vp-p	±1.0%	
⌋ (duty cycle fixed/variable)	When output 50%, range is AUTO	3.00Vp-p to 30.0Vp-p	±1.0%		
		300mVp-p to 2.99Vp-p	±1.5%		
		30.0mVp-p to 299mVp-p	±2.0%		
~ , / , \ (When frequency is 1kHz)	When output range is FXD	3.00Vp-p to 30.00Vp-p	±1.0%		
		0.30Vp-p to 2.99Vp-p	±1.5%		
DC Voltage Setting Range and Accuracy (when DC only)	Per Table B-2: DC-only Voltage Setting Range, Resolution, and Accuracy				
AC and DC setting range and DC voltage accuracy when AC + DC	Per Table B-3: AC + DC Minimum AC Amplitude, Resolution and Accuracy. The sum of AC amplitude's absolute peak and DC voltage's absolute value is less than 15V.				
Amplitude and Frequency Characteristics (in CONT mode)	1kHz reference frequency, 0V DC offset, AM off, 50Ω load, 30.0mVp-p to 30.0Vp-p amplitude setting (when output range is FXD, more than 3.00Vp-p), ~ is effective value measurement; other waveforms are p-p value.				
	~	Up to 100kHz	±0.1dB		
		100kHz to 700kHz	±0.3dB		
		700kHz to 1MHz	+0.3dB, -0.5dB		
		1MHz to 1.2MHz	+0.3dB, -1.0dB		
	~	Up to 10kHz	±3%		
⌋ (duty cycle fixed/50% variable)	Up to 100kHz	±2%			
		~ , \	Up to 10kHz	±5%	
~ Spectrum Purity (in CONT mode)	0V DC offset, AM off, 50Ω load, 30.0mVp-p to 30.0Vp-p amplitude setting (when output range is FXD, and output is >3.00Vp-p)				
	Total harmonic distortion ratio	10Hz to 100kHz	< 0.1%		
	Harmonics (when amplitude setting is 30.0Vp-p)	100kHz to 500kHz	< -40dBc		
		500kHz to 1.2MHz	< -30dBc		
	Spurious (when amplitude setting is 30.0Vp-p)	Up to 500kHz	< -55dBc		
		500kHz to 1.2MHz	< -40dBc		
⌋ Waveform Characteristics	0V DC offset, AM off, 50Ω load, 30.0mVp-p to 30.0Vp-p amplitude setting (when output range is FXD, and output is >3.00Vp-p)				
	Rise, fall time		150ns max		
	Over and undershoot		<5% of output p-p amplitude		
	Duty cycle (in CONT mode)	50% fixed accuracy		Period ±0.3% (up to 10kHz)	
		When varied	Setting range	5.0% to 95.0% (resolution 0.1%)	
			Accuracy	Period ±0.2% (up to 10kHz)	
		Jitter <150ns			
Status at Power On	Output is on.				
Output Impedance	50Ω ±1%, unbalanced (open when output is off)				
Connector	BNC, front panel				

ELECTRICAL SPECIFICATIONS (CONT.)

Sync Output	
Output Voltage	TTL Level (50Ω in series with 74HC00 output)
Connector	BNC, front panel

AM Input	
Gain	At ±1V, 100% modulation. At 0V, output is half of displayed value. At -1V DC, the carrier is suppressed.
Input Voltage Range	-3V to +1V
Modulation Range	≥100%
Modulation Signal Band	DC to 100kHz
Carrier Signal	Up to 100kHz (√)
Input Impedance	10kΩ
Connector	BNC, front panel

Frequency Sweep					
Types	Sweep functions		CONT		
	┌ (step)		┐ or └		
	LIN	∧	∨ or ∇		
		↗	↘ or ↙		
	LOG	∧	∩ or ∪		
↗		↘ or ∟			
Sweep Range	Upper limit	Same as normal oscillation			
	Lower limit	┌/LIN	0.1mHz		
		LOG	10mHz		
Minimum Sweep Width	┌, LIN	0.1mHz			
	LOG	1 decade			
Sweep Time	Setting range	5ms to 9999s			
	Display	Maximum 4 digits, minimum resolution 1ms			
	Note: Log sweep needs a minimum of 5.16ms per decade.				
Range of Settings	According to frequency of start and stop, or center and span				
Operation	CONT START	Starts continuous sweep			
	SINGL START	Starts single sweep			
	START STATE	Sets output to the start frequency output state			
	STOP STATE	Sets output to the stop frequency output state			
	HOLD/RESM	Holds and resumes sweep			
Input	Singl Start Input	Input voltage	TTL Level (input to 74HC14 is pulled up by 4.7kΩ.)		
		Signal characteristics	Single sweep starts at falling edge		
		Minimum pulse width	50ns		
		Connector	BNC, rear panel		
	Hold Input	Input voltage	TTL Level (input to 74HC14 is pulled up by 4.7kΩ.)		
		Signal characteristics	Low	Holds sweep	
			High	Resumes sweep	
		Connector	BNC, rear panel		

ELECTRICAL SPECIFICATIONS (CONT.)

Frequency Sweep (Cont.)				
Output	Sweep Sync Output	Output voltage	TTL Level (56Ω in series with 74F04 output)	
		Signal characteristics	Low	While sweeping from start frequency toward stop frequency
			High	Other cases
	Connector	BNC, rear panel		
	Marker Output	Output voltage	TTL Level (56Ω in series with 74F04 output)	
		Signal characteristics	Low	While output signal is above marker frequency during sweep
			High	Other cases
	Connector	BNC, rear panel		
	X Drive Output	Output voltage	0V to +10V (±5%) (open circuit)	
		Signal characteristics	0V to +10V (Frequency increasing)	
			+10V to 0V (Frequency decreasing)	
		Output Impedance	600Ω, unbalanced	
Load impedance		10kΩ minimum		
Connector	BNC, rear panel			
Other Functions	Replace marker frequency with center frequency			

Burst/Gate Oscillation			
Trigger Source	Internal	Internal trigger oscillator (positive/negative logic)	
	External	External trigger signal (positive/negative logic), manual trigger	
Internal Trigger Oscillator	Rate Setting Range and Display (period setting)	0.001ms to 29.999ms	
		30.00ms to 299.99ms	
		0.3000s to 2.9999s	
		3.000s to 29.999s	
		30.00s to 299.99s	
	300.0s to 2999.9s		
	Accuracy	±5 × 10 ⁻⁵ (±50ppm)	
Duty Cycle	50%		
Off/On	On only when oscillation mode is BURST or GATE, and the trigger source is internal		
Setting according to frequency	Setting range	0.4mHz to 1MHz	
	Display	Max. 5 digits, minimum resolution 0.1mHz	
	Oscillates at reciprocal period of set frequency (values below 0.4mHz are truncated)		
External Trigger Input	Input voltage	TTL level (input to 74HC14 is pulled up by 4.7kΩ)	
	Min. pulse width	200ns	
	Connector	BNC, front panel	
Internal Trigger Output	Output voltage	TTL level (56Ω in series with 74F04 output)	
	Signal Characteristics	Internal	Outputs internal trigger oscillation signal
		External	Outputs external trigger input signal
Connector	BNC, rear panel		
Start/stop Phase	Set. range	-360° to 360°	
	Display	Max. 4 digits ± display, resolution 0.1° (fixed)	
Trigger Delay	Approx. 600ns (jitter 150 ns)		

Digital Out	
Output Voltage	TTL Level
Connector	36-pin, rear panel

ELECTRICAL SPECIFICATIONS (CONT.)

Memory	
Memory Contents	Main Frequency*, amplitude*, DC offset*, waveform, oscillation mode Sweep-Related Start*, stop*, center*, span*, marker*, frequency, sweep time*, sweep function Trigger-Related Trigger source, internal trigger rate*, burst wave number*, start/stop phase* Other <input type="checkbox"/> duty cycle*, AM on/off, beep sound (on/off), output range mode AUTO/FXD Modify Note: Parameters listed with * show cursor position and step size.
Number of Memory Units	10 units
Battery Backup	30 days or more after full charge (stored at room temperature)

Setting Protection When Power is Off	
Functions	Parameters in effect prior to power-off are stored and become effective at next power on, (except for waveform output on/off).
Storage Contents	Same items as in Memory Contents, plus lock (on/off), GPIB address, delimiter.
Battery Backup	Identical to Memory

Modify		
Format	Per cursor movement and MODIFY knob.	
Up/Down Step Size	±1	Increases or decreases the cursor position value by 1.
	±5	Increases or decreases the cursor position value by 5.
	x÷2	Multiplies or divides entire value by 2.
	x÷10	Multiplies or divides entire value by 10.
	Note: The above step sizes apply only to the parameters listed with * in Memory Contents. Others change step size by ±1 only, and cursor position is fixed.	
Parameters that can't be modified	Memory number, GPIB address, and delimiter	

Display Function
Synchronously displays waveform output on/off, frequency, amplitude, DC offset, waveform, oscillation mode, AM on/off, and sweep state.

Lock
Disables most front panel key entries and operating condition changes. Current parameter values can be displayed. GPIB input and certain BNC inputs are enabled.

ELECTRICAL SPECIFICATIONS (CONT.)

Preset

Sets the parameters listed below.

The modification step size is ± 1 . The underline indicates the cursor position.

Main

Frequency	<u>1</u> .0000000kHz
Amplitude	<u>3</u> .00mVp-p (0.00Vp-p)
DC offset	<u>0</u> .00mV (0.00V)
Waveform	<u>~</u>
Oscillation mode	CONT

Sweep-Related

Start frequency	<u>1</u> .0000000kHz
Stop frequency	<u>10</u> .0000000kHz
Center frequency	<u>5</u> .5000000kHz
Span Frequency	<u>9</u> .0000000kHz
Marker frequency	<u>5</u> .0000000kHz
Sweep time	<u>1</u> .000s
Sweep function	LIN <u>^</u>

Trigger-Related

Trigger source	INT <u>∇</u>
Internal trigger rate	<u>2</u> .000ms
Burst wave number	<u>1</u> cycle
Start/stop phase	<u>0</u> .0 deg

Others

AM	off
<u>□</u> Duty cycle	<u>50</u> .0% fixed
Beep sound	on
Output range mode	AUTO

Display

Main parameter display status

B.2 GPIB INTERFACE

GPIB Interface		
Functions	SH1	Full source handshake capability
	AH1	Full acceptor handshake capability
	T6	Basic talker, serial poll, taken unaddressed if MLA
	L4	Basic listener, unaddressed if MTA
	SR1	Full service request capability
	RL1	Full remote and local operation capability
	PP0	No parallel-poll function capability
	DC1	Full device clear capability
	DT0	No controller function capability
	C0	No controller function capability
Data	ISO 7-bit code (ASCII code)	
Delimiter	Transmission	CR or CR/LF (panel) EOI also sent simultaneously.
	Reception	CR, CR/LF, CR + EOI, CR/LF + EOI, or EOI
Address	0 - 30 (selected by numeric keys on the front panel)	
Output Driver	DIO1 - DIO8, NDAC, NRFD, SRQ	Open collector
	DAV, EOI	Tri-state
Local Key	Switch for return-to-local function	
Connector	IEEE-488 24-pin GPIB connector, rear panel	

B.3 GENERAL

Signal Ground	The grounding pins of all input/output connectors are connected to the chassis.	
Power Source	Voltage	100, 120, 220 or 240V AC $\pm 10\%$ (250V max.)
	Frequency	48 - 62Hz
	Power Consumption	Approx. 34VA
Range of Ambient Temperature and Humidity	Operating	0° - 40°C, 10 - 90% RH (without condensation)
	Storage	-10° - 50°C, 10 - 80% RH (without condensation)
External Size	Excluding Projections	216 (W) \times 132.5 (H) \times 350 (D) mm, 8.5 (W) \times 5-1/4 (H) \times 13-3/4 (D) in.
Weight	Approx. 4.6kg (10 lbs.)	

Table B-1. AC Amplitude Setting Range for 0V DC Offset

Output Range Mode	AC (p-p)	~		Hardware Resolution (p-p)	Output Attenuator (See note)
		rms	dBV		
AUTO	30.0V to 3.00V	10.6V to 1.06V	20.5 to 0.5	15mV	1/1
	2.99V to 300mV	1.05V to 106mV	0.4 to 19.5	1.5mV	1/10
	299mV to 30.0mV	105mV to 10.6mV	-19.6 to -39.5	150μV	1/100
	29.9mV to 0.30mV	10.5mV to 0.11mV	-39.6 to -79.2	15μV	1/1000
FXD	30.00V to 0.00V	(Vp-p only)	(Vp-p only)	15mV	1/1

Output Range Mode	AC (p-p)	~ / ~ / ~		Hardware Resolution (p-p)	Output Attenuator (See note)
		rms	dBV		
AUTO	30.0V to 3.00V	8.66V to 866V	18.8 to 1.2	15mV	1/1
	2.99V to 300mV	1865V to 86.6mV	-1.3 to -21.2	1.5mV	1/10
	299mV to 30.0mV	86.5mV to 8.66mV	-21.3 to -41.2	150μV	1/100
	29.9mV to 0.30mV	8.65mV to 0.09mV	-41.3 to -80.9	15μV	1/1000
FXD	30.00V to 0.00V	(Vp-p only)	(Vp-p only)	15mV	1/1

Output Range Mode	AC (p-p)	□		Hardware Resolution (p-p)	Output Attenuator (See note)
		rms	dBV		
AUTO	30.0V to 3.00V	15.0V to 1.50V	23.5 to 3.5	15mV	1/1
	2.99V to 300mV	1.49V to 150mV	3.4 to -16.5	1.5mV	1/10
	299mV to 30.0mV	149mV to 15.0mV	-16.6 to -36.5	150μV	1/100
	29.9mV to 0.30mV	14.9mV to 0.15mV	-36.6 to -76.2	15μV	1/1000
FXD	30.00V to 0.00V	(Vp-p only)	(Vp-p only)	15mV	1/1

Note: When switching the output attenuator, the instantaneous waveform output goes off.

Table B-2. DC Only Voltage Setting Range, Resolution, and Accuracy (open load, 18°-28°C)

Output Range Mode	DC (+ or -)	Hardware Resolution	Accuracy	Output Attenuator (See note)
AUTO	15.0V to 1.50V	7.3mV	±(0.1% + 8mV)	1/1
	1.49 to 150mV	730μV	±(0.6% + 0.8mV)	1/10
	149mV to 15.0mV	73μV	±(1% + 80μV)	1/100
	14.9mV to 0.00mV	7.3μV	(Not specified)	1/1000
FXD	15.00V to 0.00V	7.3mV	±(0.1% + 8mV)	1/1

Note: When switching the output attenuator, the instantaneous waveform output goes off.

Table B-3. AC + DC Minimum AC Amplitude, Resolution, and Accuracy (open load)

Output Range Mode	Cumulative Voltage (See Note 2)	Minimum AC Amplitude							Hard. AC V Resl.	Hard. DC V Resl.	DC Voltage Accuracy	Output Atten. (See Note 1)
		p-p	~		~ / \		⌋					
			rms	dBV	rms	dBV	rms	dBV				
AUTO	More than 1.5V	286mV	101mV	-19.9	82.5mV	-21.6	143mV	-16.9	15mVp-p	7.3mV	±(0.2% of AC amplitude setting (p-p) +0.1% of DC voltage setting +8mV)	1/1
	More than 150mV	28.6mV	10.1mV	-39.9	8.25mV	-41.6	14.3mV	-36.9	1.5mVp-p	730μV	±(0.2% of AC amplitude setting (p-p) +0.6% of DC voltage setting +0.8mV)	1/10
	More than 15mV	2.86mV	1.01mV	-59.9	0.83mV	-61.6	1.43mV	-56.9	150μVp-p	73μV	±(0.2% of AC amplitude setting (p-p) +1% of DC voltage setting +80μV)	1/100
	Less than 15mV	0.30mV	0.11mV	-79.2	0.09mV	-80.9	0.15mV	-76.5	15μVp-p	7.3μV	(Not specified)	1/1000
FXD	Not related to cumulative voltage	0.00V	(Vp-p only)						15mVp-p	7.3mV	±(0.2% of AC amplitude setting (p-p) +0.1% of DC voltage setting +8mV)	1/1

Notes:

1. When switching the output attenuator, the instantaneous waveform output goes off.
2. Cumulative voltage = AC amplitude setting (p-p) divided by 2 plus DC voltage setting (V).
3. DC voltage accuracy is when frequency is about 1kHz, ~, AM off, open load, 18°-28°C.

Figure B-1. Outer Dimensions of the Model 3330A

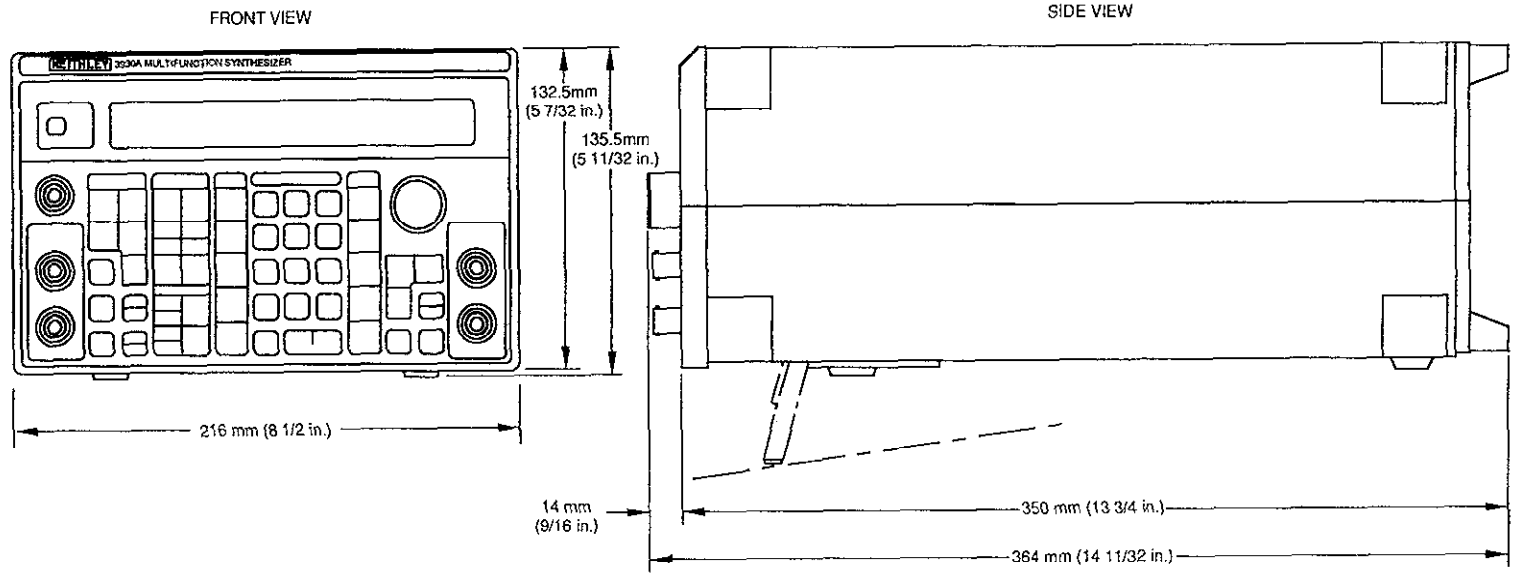

Index

A

Amplitude Modulation (AM), 3-21
Amplitude Units Conversion, 3-20
Analog Input, 3-13
Analog Outputs, 3-14

B

Basic Controller Functions, 4-4
Basic Listener Functions, 4-3
Basic Talker Functions, 4-3
Burst Cycle, 3-27
Burst Mode, 3-26
Bus Driver, 4-6
Bus Line Signals, 4-2

C

Codes, 4-6
Continuous Mode, 3-24
Continuous Sweep, 3-30

D

DC Offset, 3-21
Delimiter, 4-7

E

Error Codes, 3-17, 4-10

F

Fan, 2-1
FEATURES, 1-1
Frequency Programming, 3-20
Frequency Sweep Operation, 3-29
Frequency Units Conversion, 3-19
Front Panel Description, 3-1
Front Panel Summary, 2-3

G

Gate Mode, 3-26
GPIB Handshaking, 4-2
GPIB Overview, 4-1
GPIB Primary Address, 4-6
GPIB Specifications, 4-1

H

HANDLING PRECAUTIONS, 2-3
Holding/Resuming a Sweep, 3-32

I

INSTALLATION, 2-1
Input Connections, 3-13
Inquiry Messages, 4-9, 4-21
Interface Functions, 4-6
Internal Rate, 3-27
Internal Trigger Rate Units Conversion, 3-19

L

LINE POWER SUPPLY, 2-2
LINE Voltage Selector Switch, 2-2
Line Fuse, 2-2
Line Receptacle Connection, 2-2
Linear Sweep Steps, 3-33
Log Sweep Steps, 3-34
Logic Input, 3-13
Logic Outputs, 3-14

M

MANUAL ADDENDA, 1-2
MODEL 3930A GPIB INTERFACE, 4-6
MODEL 3930A PROGRAM CODES, 4-10
MODEL 3933A PHASE SHIFTER PROGRAM CODES, 4-26
MODIFY, 3-17
Model 3933A Phase Shifter Inquiry Messages, 4-32
Multi-Line Interface Messages, 4-4

N

Numeric Keys, 3-16

O

OPERATING PROCEDURES, 3-16
OPTIONAL ACCESSORIES, 1-3
Operating Examples, 2-5
Oscillation Mode Selection, 3-24
Output Amplitude, 3-21
Output Connections, 3-14
Output Considerations, 3-14

Output Range Mode, 3-34

P

Parameter Setting Messages, 4-7

PROGRAM CODE SUMMARY TABLES, 4-38

Program Codes, 4-7

R

Repacking, 1-3

Response to Interface Messages, 4-7

S

SAFETY TERMS AND SYMBOLS, 1-2

SAMPLE PROGRAMS, 4-43

Service Request (SRQ), 4-10

Single Sweep, 3-32

Square-Wave Duty Cycle, 3-23

STARTUP, 3-15

Start Frequency, 3-32

Start/Stop Phase, 3-27

Status Byte, 4-11

Stop Frequency, 3-32

Substituting Marker Frequency, 3-33

Sweep Function, 3-30

Sweep Operations, 3-30

Sweep Range, 3-29

Sweep Time, 3-30

Synchronous Output, 3-24

T

Trigger Source, 3-27

Turning a Sweep Off, 3-32

TYPICAL EXECUTION TIMES, 4-35

Typical Data, A-1

Typical Test Connections, 2-3

U

Units Conversion, 3-19

Unpacking, 1-2

W

WARRANTY, 1-2

Waveform Selection, 3-23



Service Form

Model No. _____ Serial No. _____ Date _____

Name and Telephone No. _____

Company _____

List all control settings, describe problem and check boxes that apply to problem. _____

- | | | |
|--|--|--|
| <input type="checkbox"/> Intermittent | <input type="checkbox"/> Analog output follows display | <input type="checkbox"/> Particular range or function bad; specify |
| <input type="checkbox"/> IEEE failure | <input type="checkbox"/> Obvious problem on power-up | <input type="checkbox"/> Batteries and fuses are OK |
| <input type="checkbox"/> Front panel operational | <input type="checkbox"/> All ranges or functions are bad | <input type="checkbox"/> Checked all cables |

Display or output (check one):

- | | |
|---|--|
| <input type="checkbox"/> Drifts | <input type="checkbox"/> Unable to zero |
| <input type="checkbox"/> Unstable | <input type="checkbox"/> Will not read applied input |
| <input type="checkbox"/> Overload | |
| <input type="checkbox"/> Calibration only | <input type="checkbox"/> Certificate of calibration required |
| <input type="checkbox"/> Data required | |

(attach any additional sheets as necessary)

Show a block diagram of your measurement system including all instruments connected (whether power is turned on or not). Also, describe signal source.

Where is the measurement being performed? (factory, controlled laboratory, out-of-doors, etc.)

What power line voltage is used? _____ Ambient temperature? _____ °F

Relative humidity? _____ Other? _____

Any additional information (If special modifications have been made by the user, please describe.)

Be sure to include your name and phone number on this service form.